

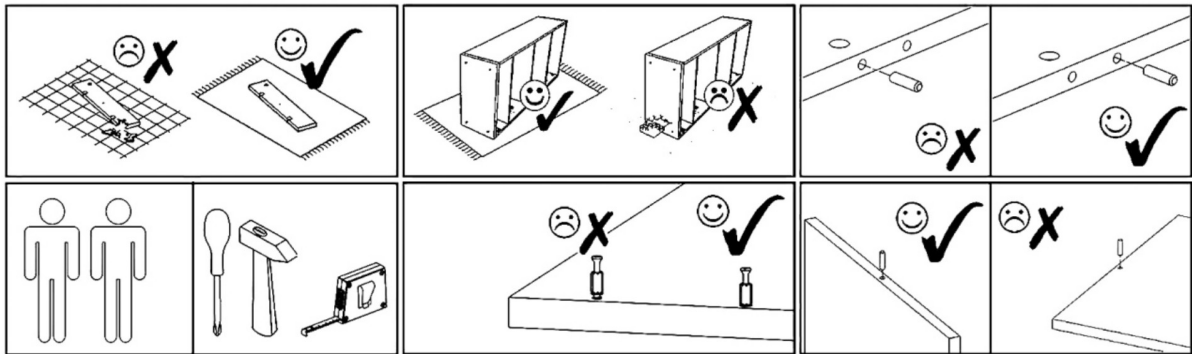

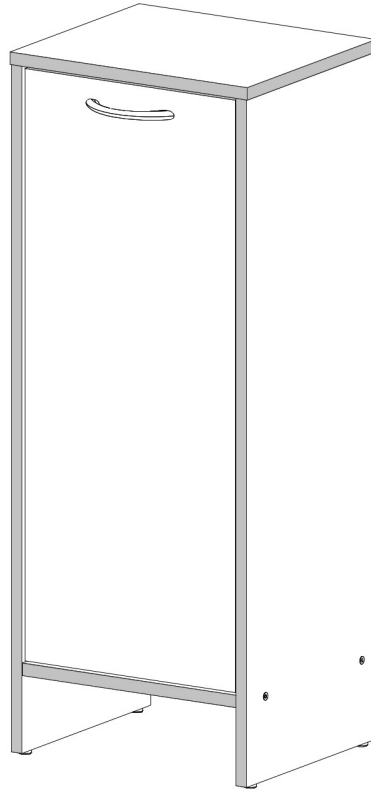







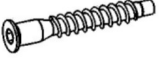







NINA 1D

PRODUCTION DATE

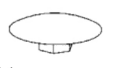
PACKING CODE





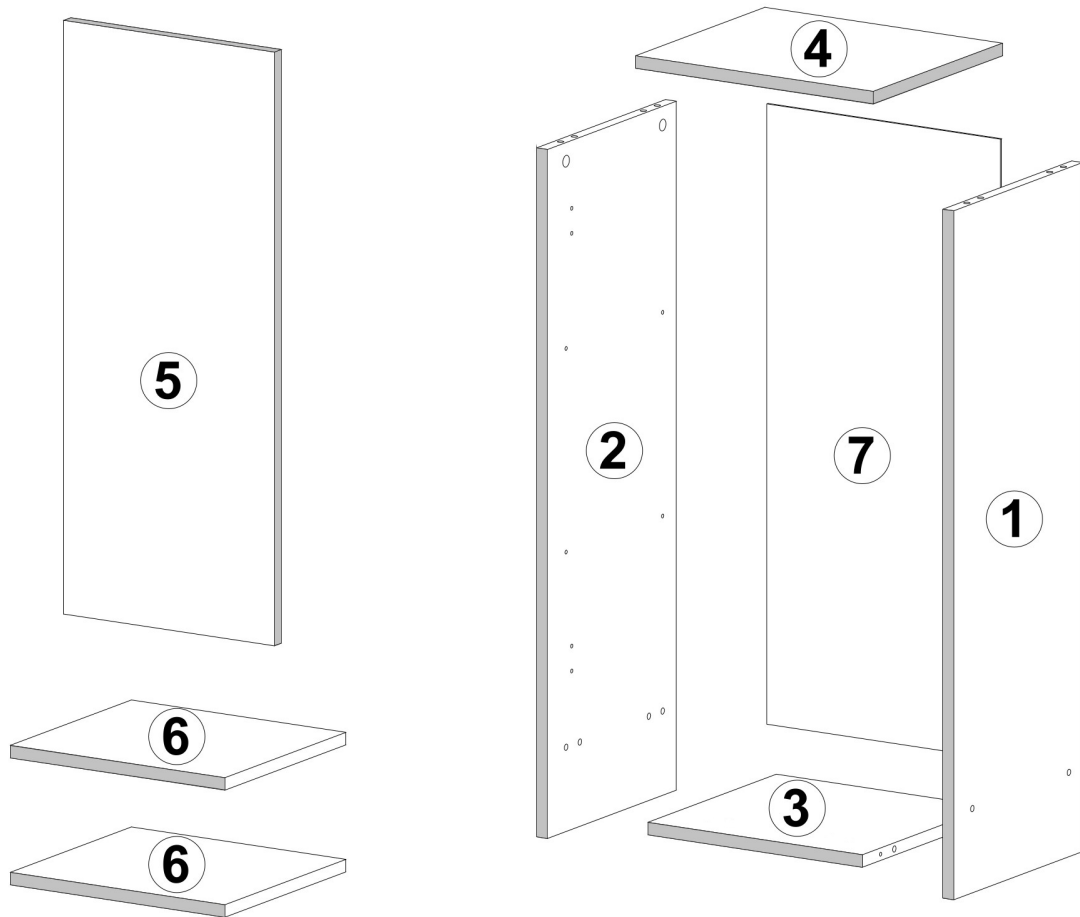

E1  8x30mm x8	F1  7x50mm x4	F3  Hex 4mm x1	V16  5x16mm x8	N1  L=35mm x4	M1  12x15mm x4	T1  x4	U15  L=125/96mm x1
S2  4x27mm x2	Z1  x40	A2  ZW x2	S1  3,5x16mm x4	V13  x1	B2  Ant ø12/4mm x4	B2  S/A ø12/4mm x4	B2  B ø12/4mm x4
B2  K ø12/4mm x4	V58  D=10mm x2						

NINA 1D





PRODUCTION DATE	PACKING CODE

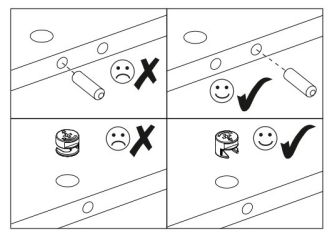
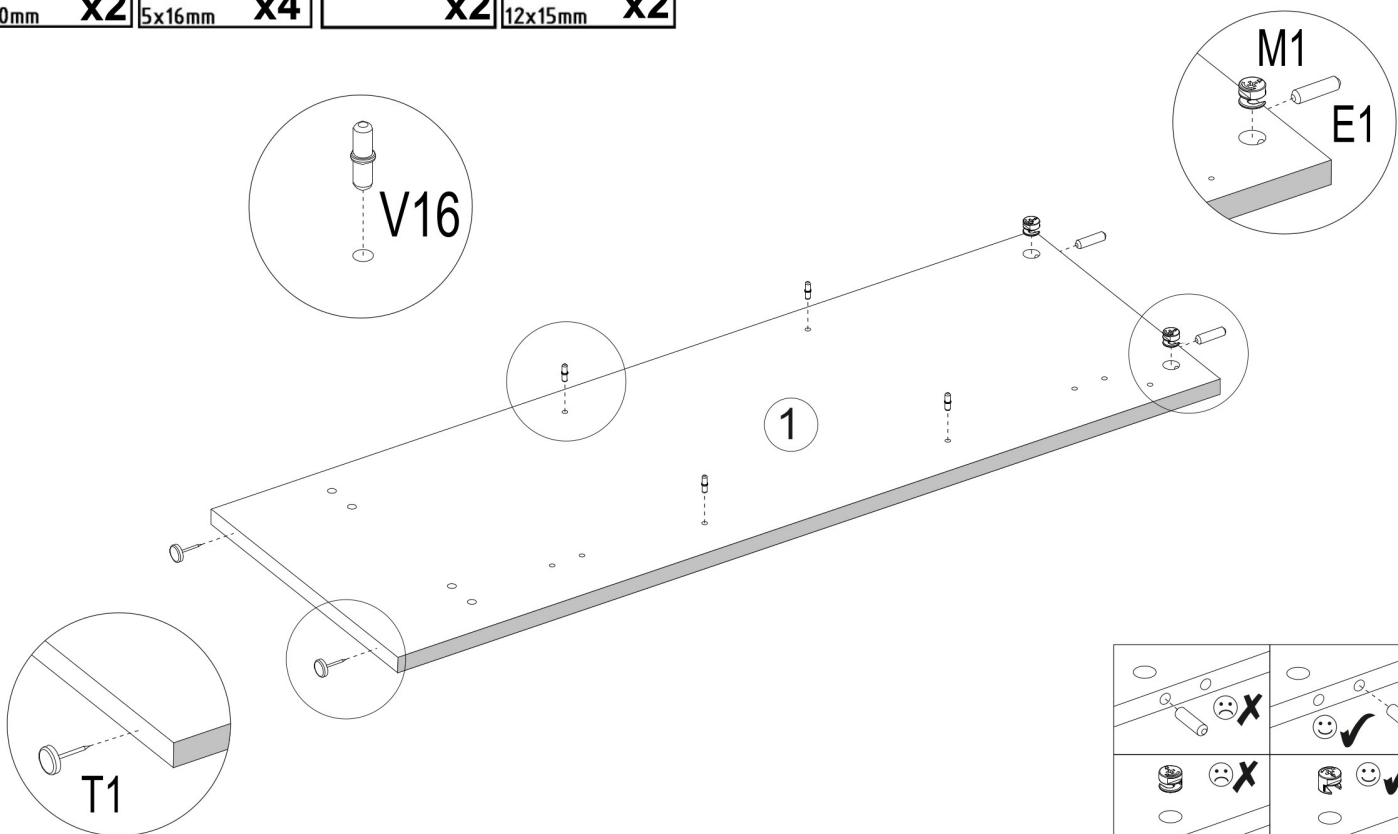

001967	1	1
001968	2	1
001936	3	1
001937	4	1
001970	5	1
001941	6	2
001969	7	1
ID	NUMBER	QUANTITY

<p>E1</p>  <p>8x30mm x2</p>	<p>V16</p>  <p>5x16mm x4</p>	<p>T1</p>  <p>x2</p>	<p>M1</p>  <p>12x15mm x2</p>
--	---	---	---





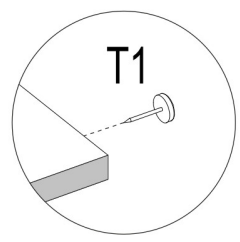
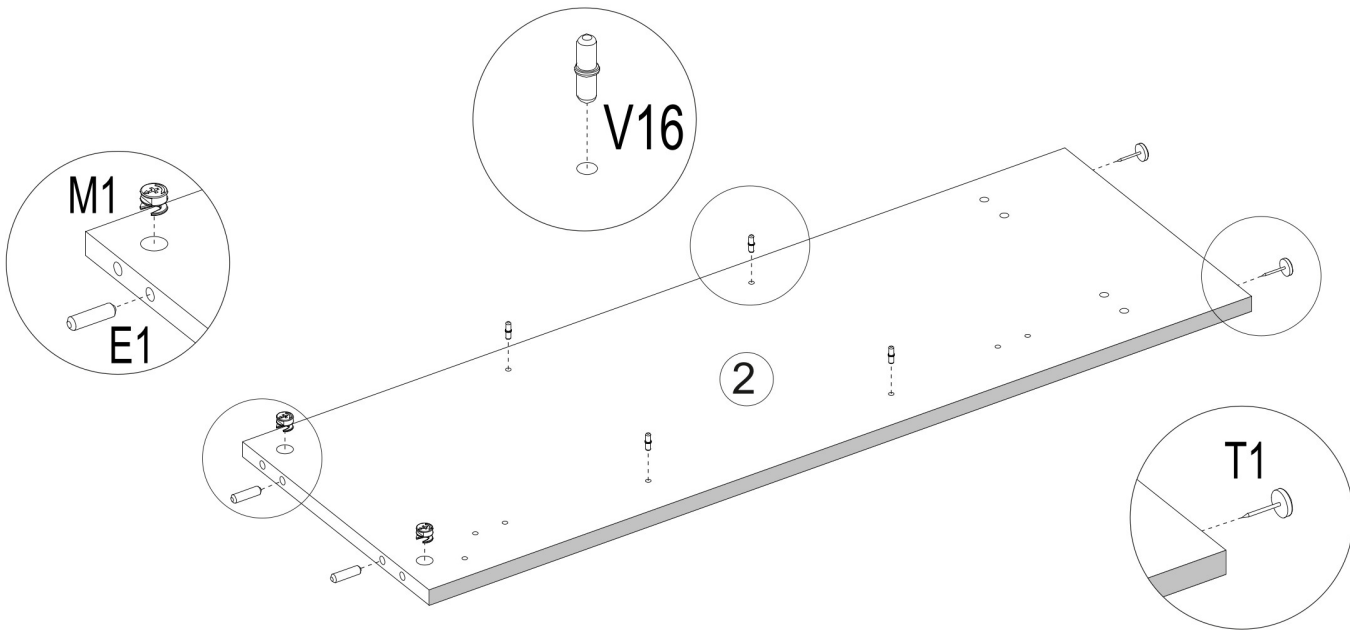
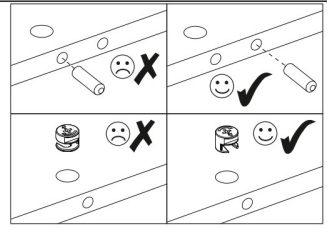

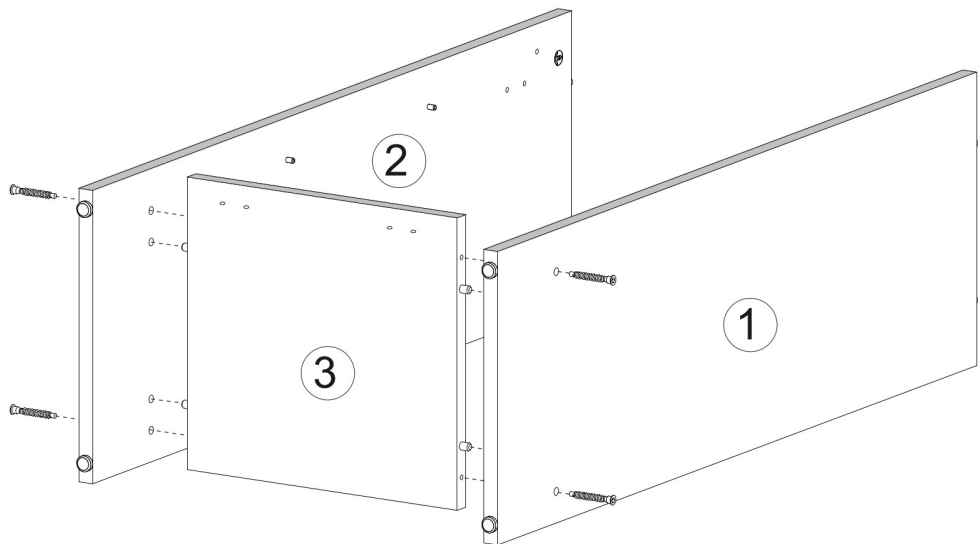
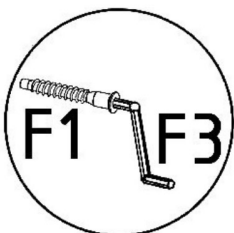
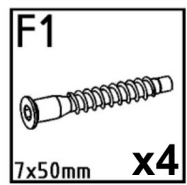
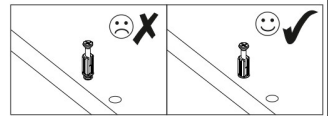
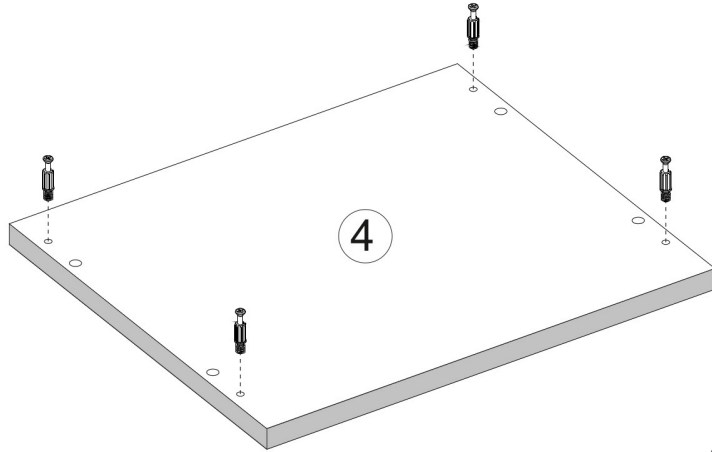
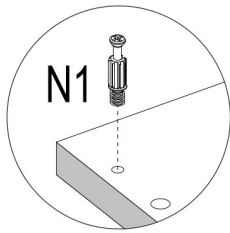
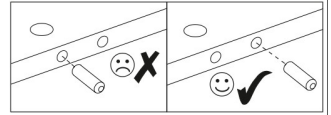
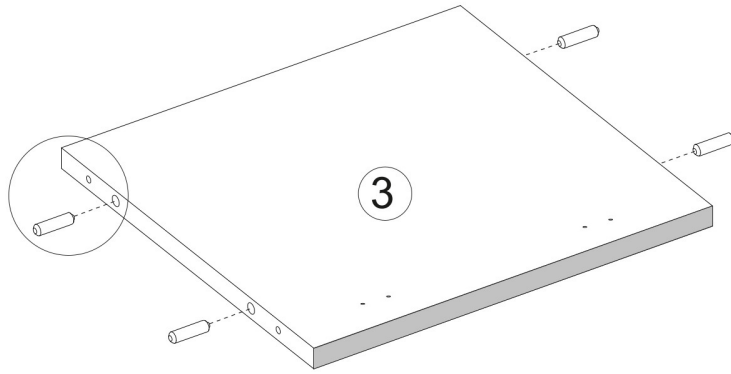
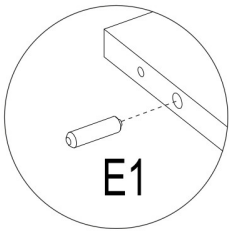
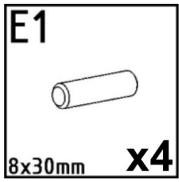

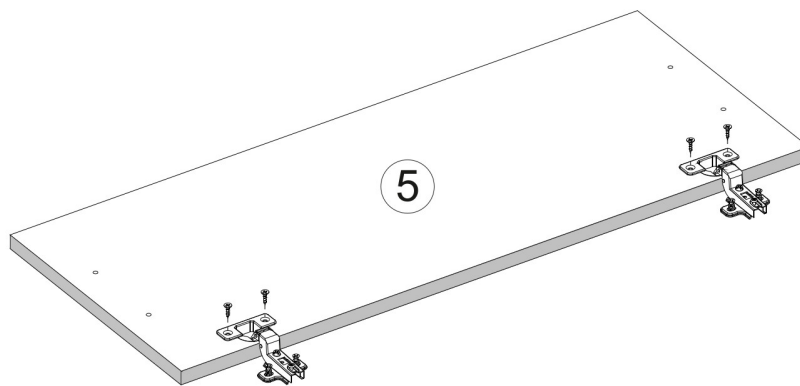
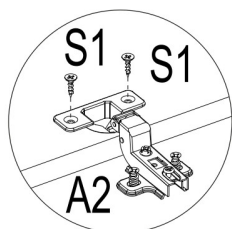
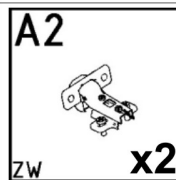
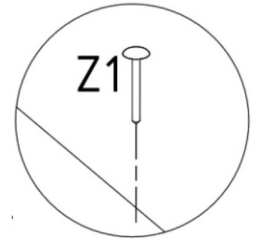
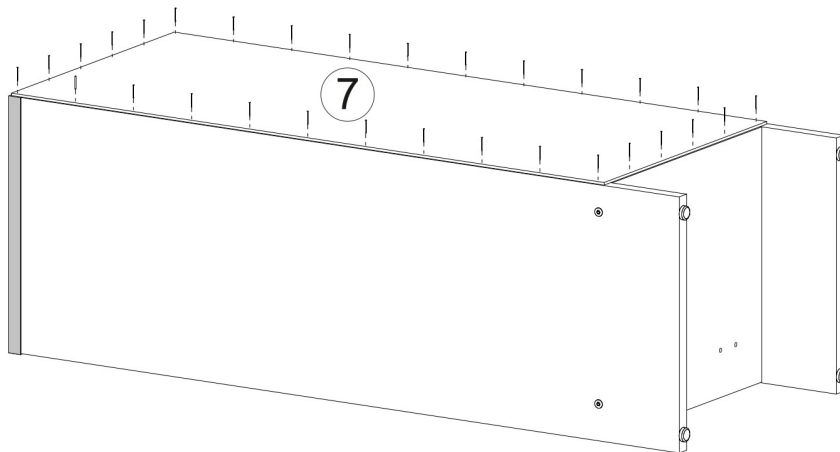
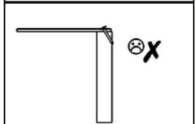
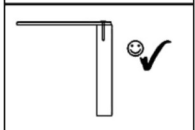
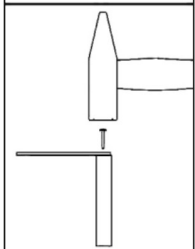
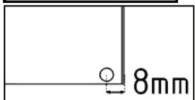
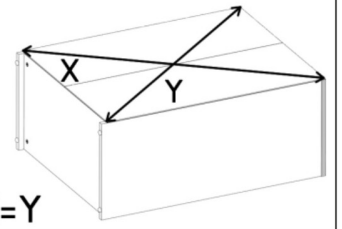
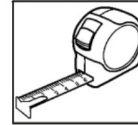
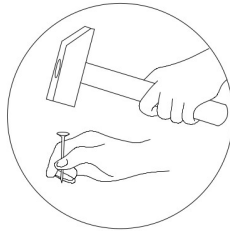
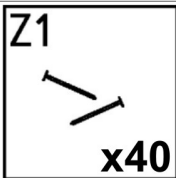
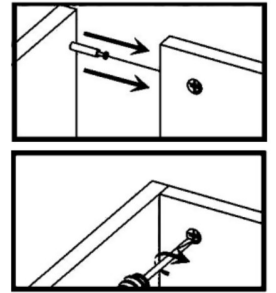
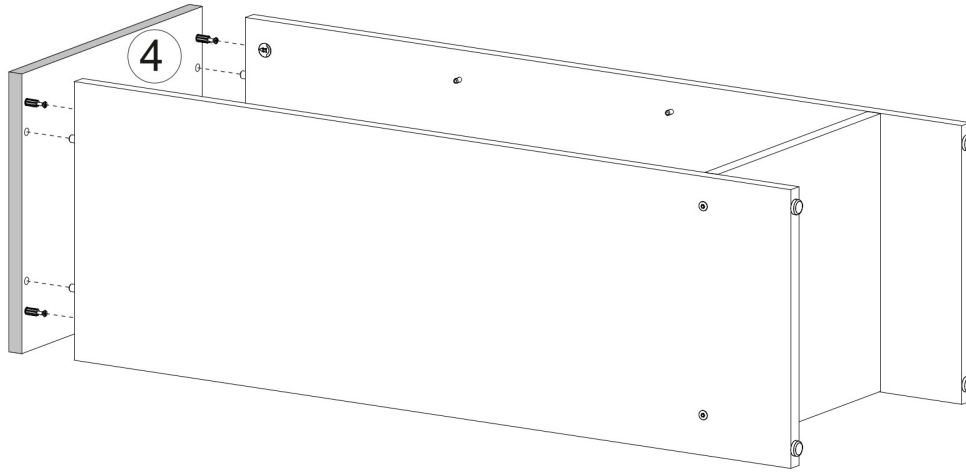

<p>E1</p>  <p>8x30mm x2</p>	<p>V16</p>  <p>5x16mm x4</p>	<p>T1</p>  <p>x2</p>	<p>M1</p>  <p>12x15mm x2</p>
--	---	---	---









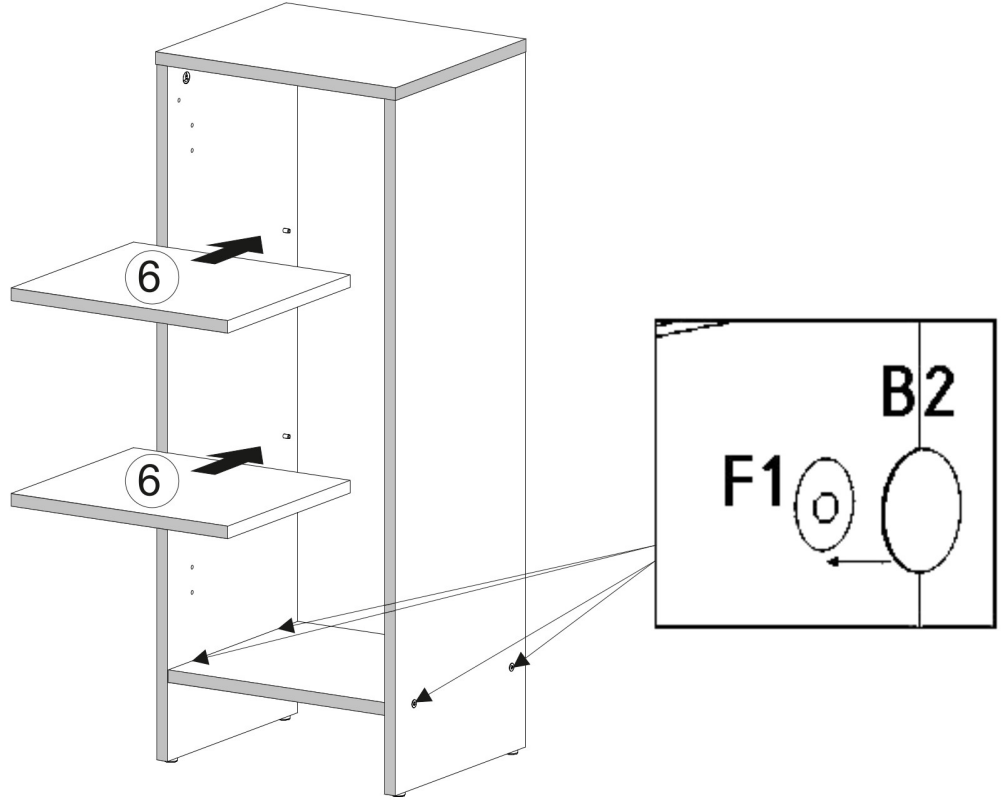

V13  x1	B2  ø12/4mm x4
--	---

					
---	---	--	---	---	---



S2  4x27mm x2	U15  L=125/96mm x1	V58  D=10mm x2
---	---	---

