

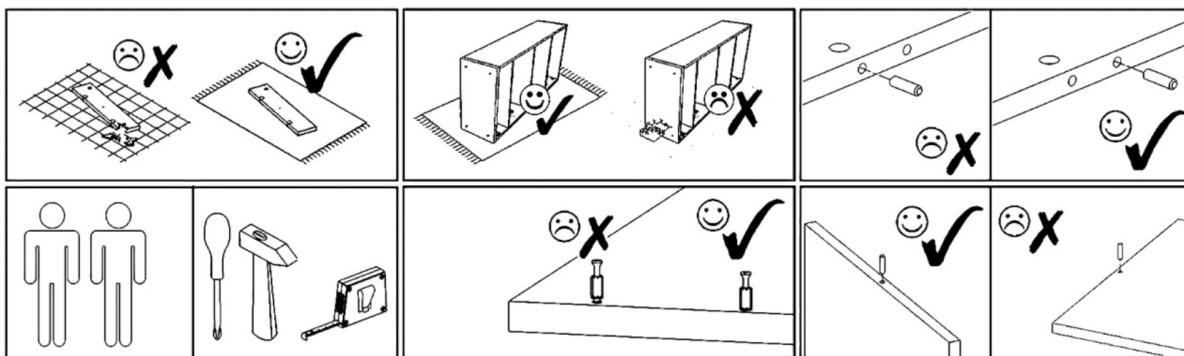

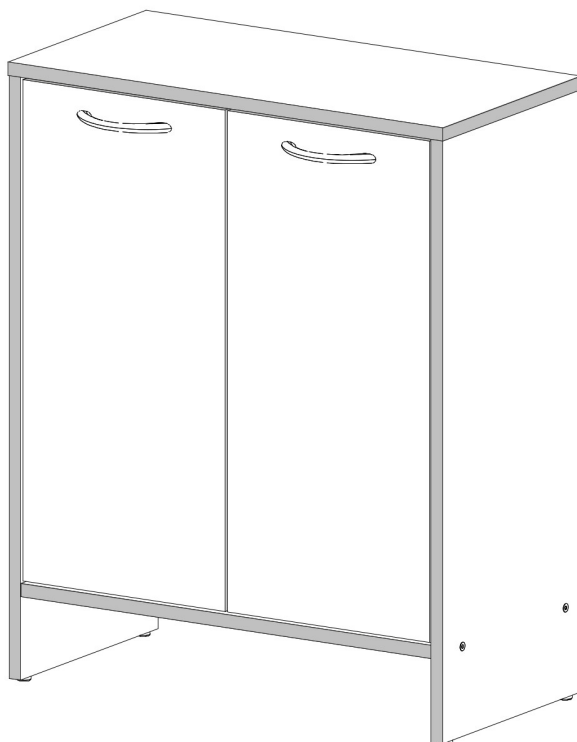







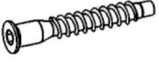







# NINA 2DUM

PRODUCTION DATE

PACKING CODE



<b>E1</b>  8x30mm <b>x8</b>	<b>F1</b>  7x50mm <b>x4</b>	<b>F3</b>  Hex 4mm <b>x1</b>	<b>V16</b>  5x16mm <b>x4</b>	<b>N1</b>  L=35mm <b>x4</b>	<b>M1</b>  12x15mm <b>x4</b>	<b>T1</b>  <b>x4</b>	<b>U15</b>  L=125mm <b>x2</b>
<b>S2</b>  4x27mm <b>x4</b>	<b>Z1</b>  <b>x50</b>	<b>A2</b>  ZW <b>x4</b>	<b>S1</b>  3,5x16mm <b>x8</b>	<b>V13</b>  <b>x1</b>	<b>B2</b>  Ant. $\varnothing$ 12/4mm <b>x4</b>	<b>B2</b>  S/A. $\varnothing$ 12/4mm <b>x4</b>	<b>B2</b>  B. $\varnothing$ 12/4mm <b>x4</b>
<b>B2</b>  K $\varnothing$ 12/4mm <b>x4</b>	<b>V58</b>  D=10mm <b>x2</b>						



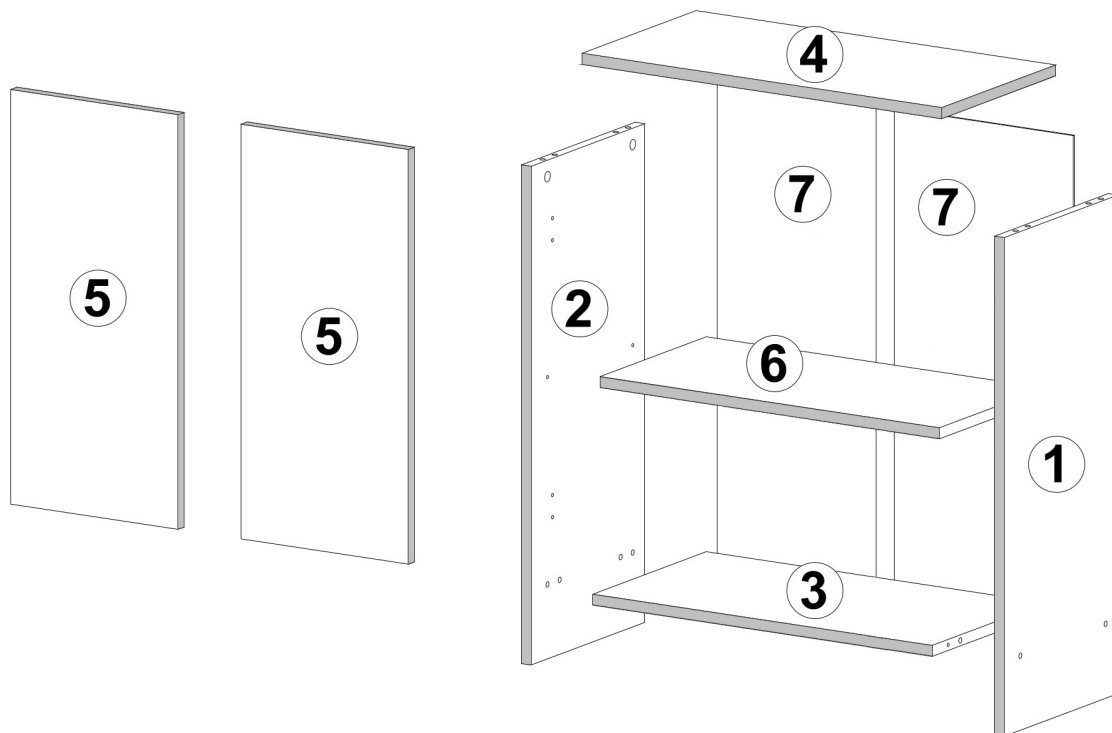

# NINA 2DUM

PRODUCTION DATE





PACKING CODE

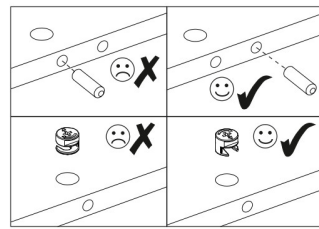
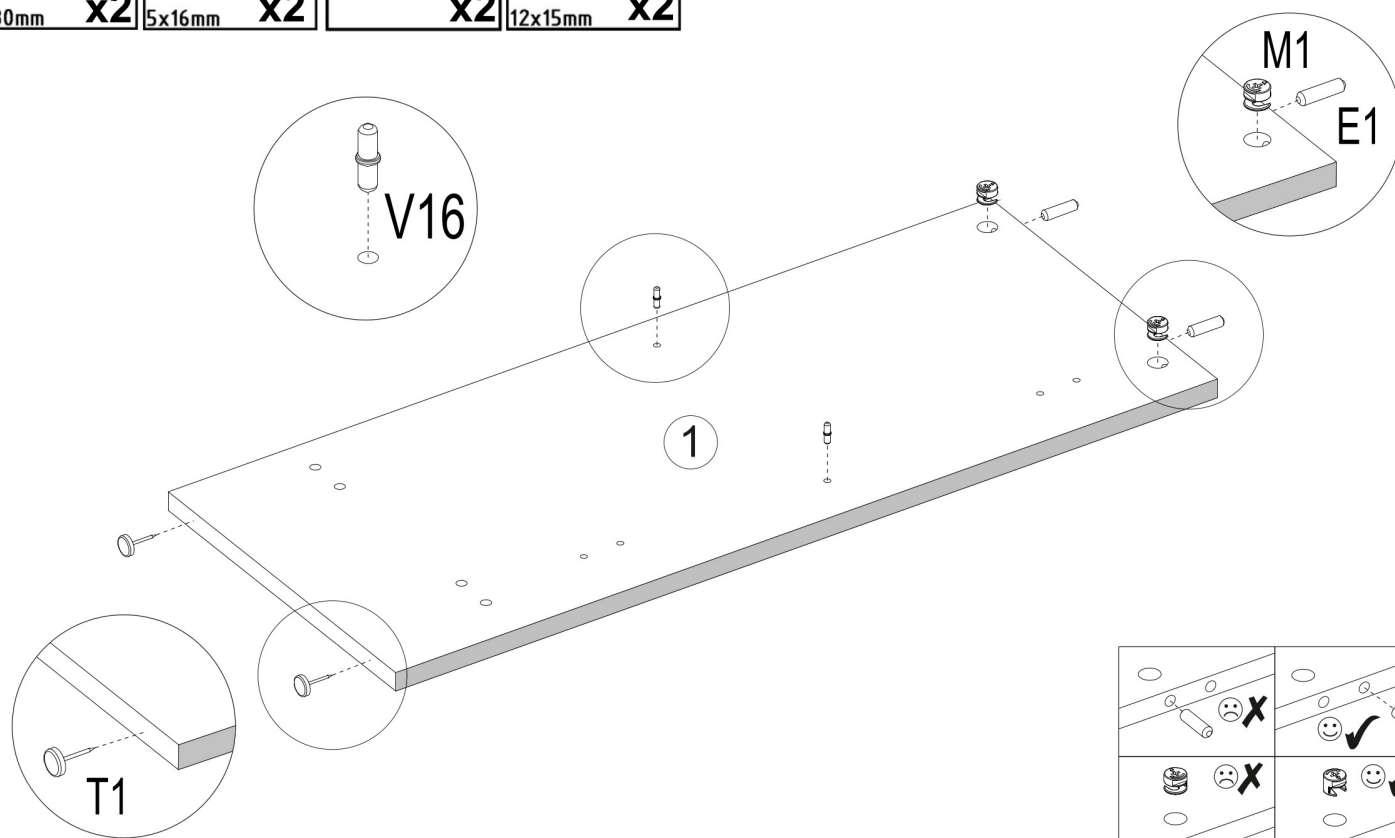

001961	1	1
001960	2	1
001964	3	1
001963	4	1
001962	5	2
001965	6	1
001966	7	2
<b>ID</b>	<b>NUMBER</b>	<b>QUANTITY</b>

<b>E1</b>  8x30mm <b>x2</b>	<b>V16</b>  5x16mm <b>x2</b>	<b>T1</b>  <b>x2</b>	<b>M1</b>  12x15mm <b>x2</b>
--	---	---	---



<b>E1</b>  8x30mm <b>x2</b>	<b>V16</b>  5x16mm <b>x2</b>	<b>T1</b>  <b>x2</b>	<b>M1</b>  12x15mm <b>x2</b>
--	---	---	---

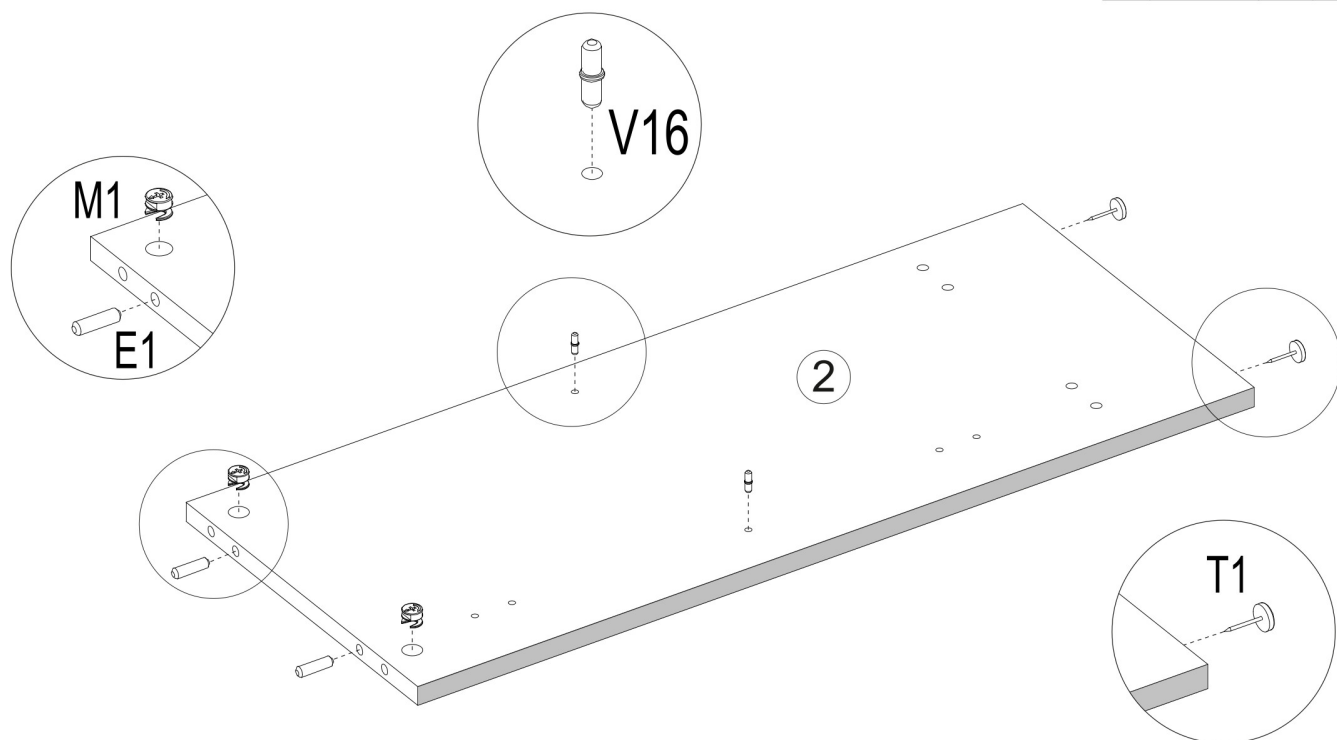
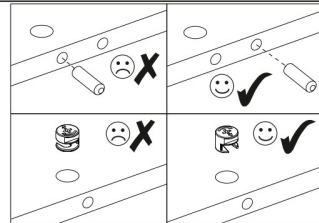

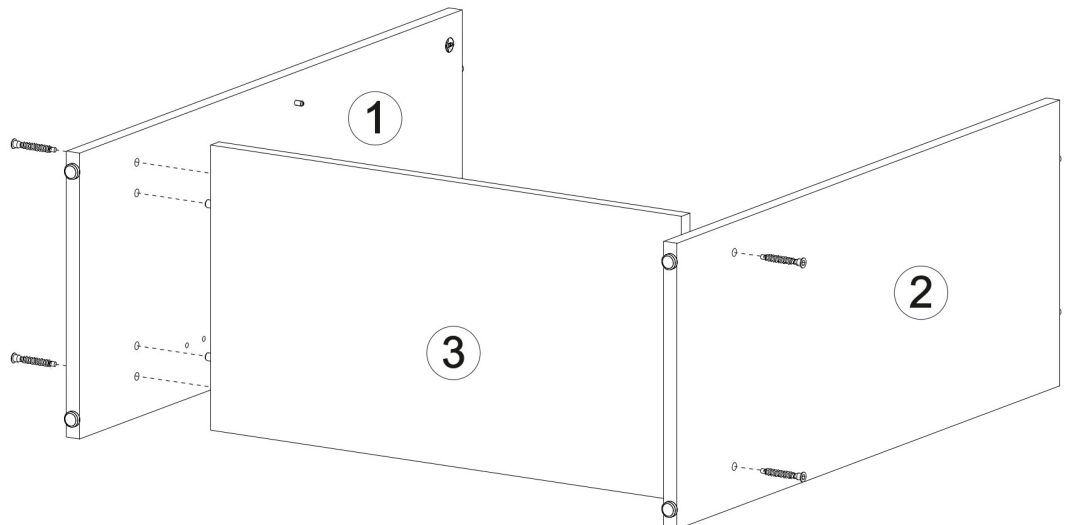
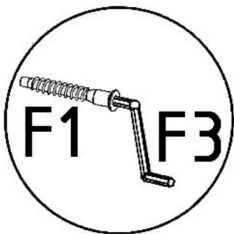
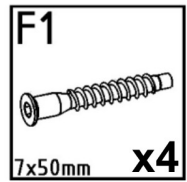
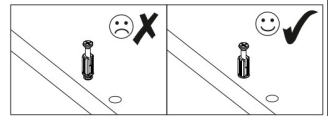
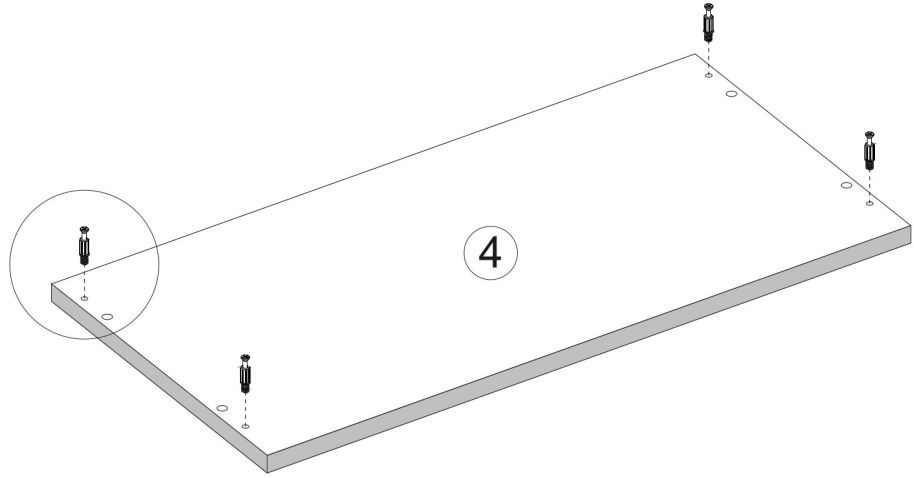
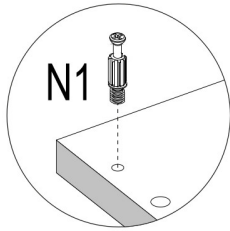
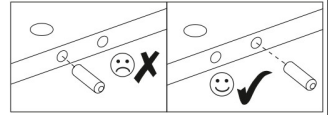
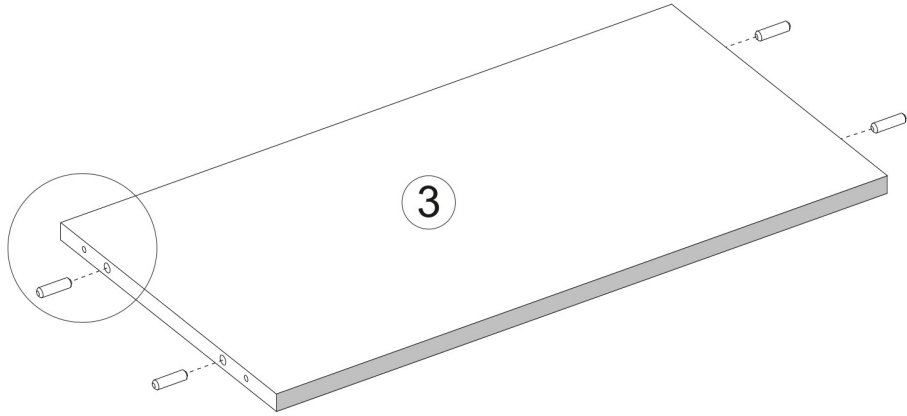
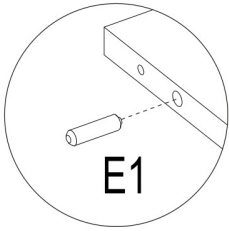
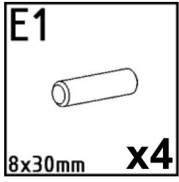

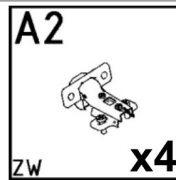
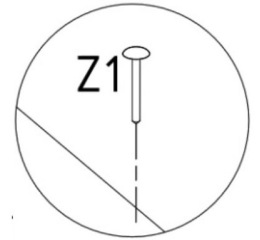
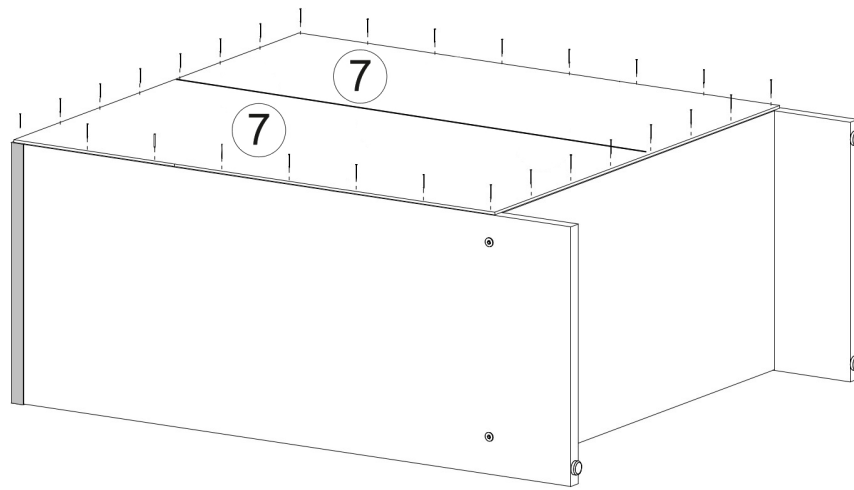
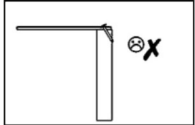
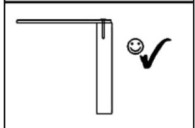
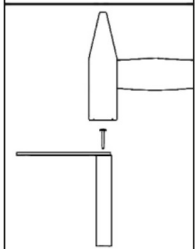
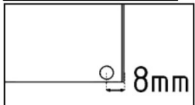
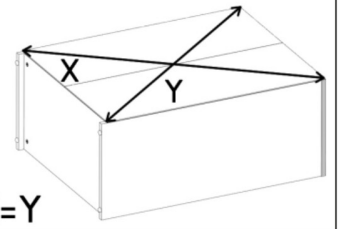
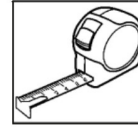
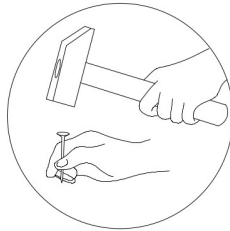
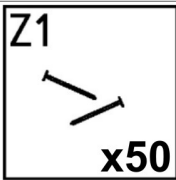
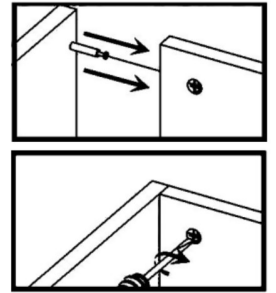
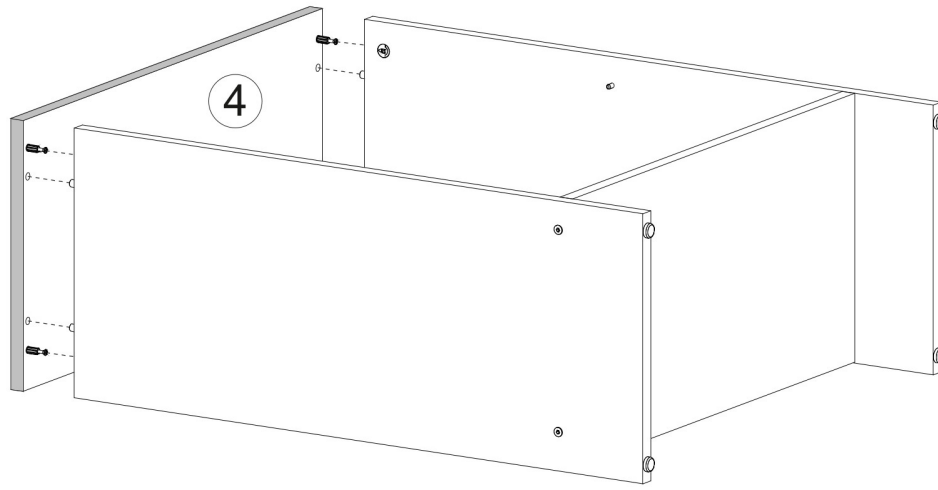

**x2**

