

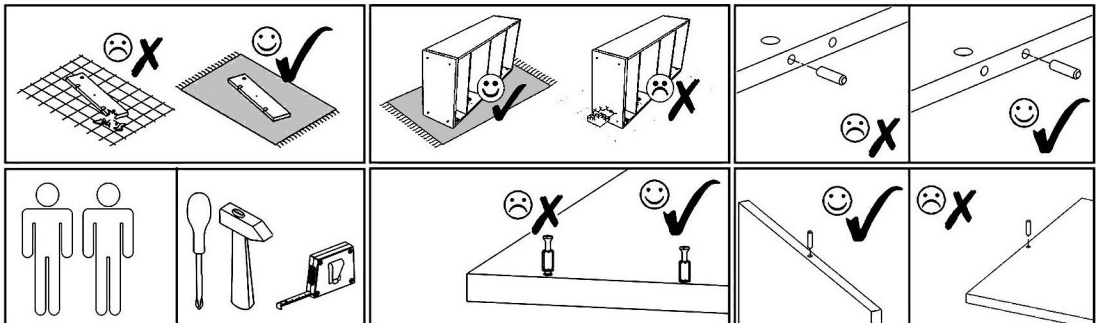

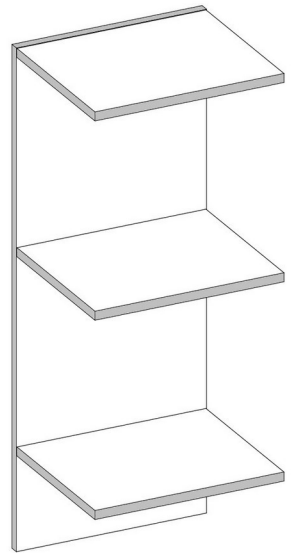
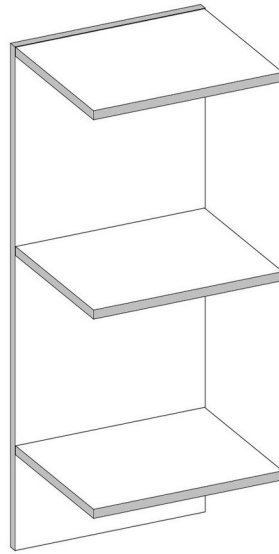
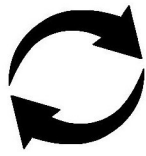
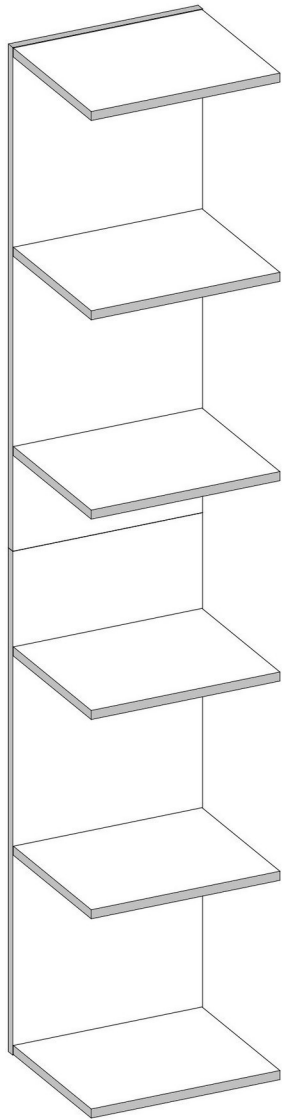
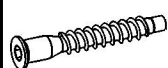
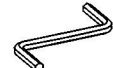

R6P

PRODUCTION DATE

PACKING CODE



<p>F1</p>  <p>7x50mm x18</p>	<p>F3</p>  <p>Hex 4mm x1</p>	<p>V52</p>  <p>^B D=10mm x4</p>	<p>V52</p>  <p>^{S-A} D=10mm x4</p>	<p>V52</p>  <p>^K D=10mm x4</p>	<p>V52</p>  <p>^{Ant} D=10mm x4</p>
--	---	--	--	--	---

R6P

PRODUCTION DATE

PACKING CODE

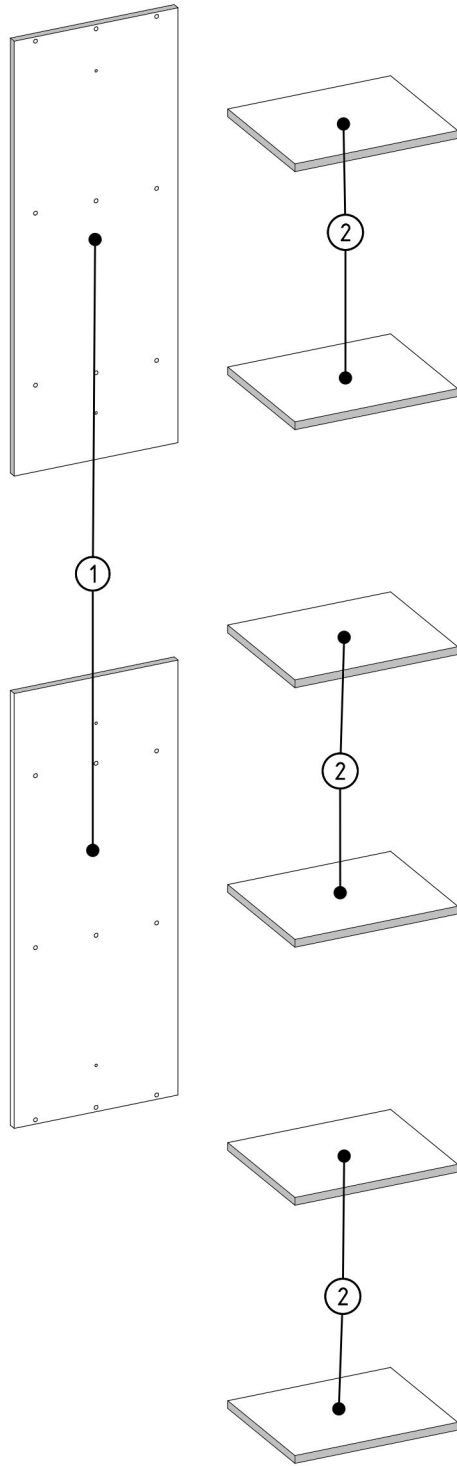

001928	2	6
001927	1	2
ID	NUMBER	QUANTITY

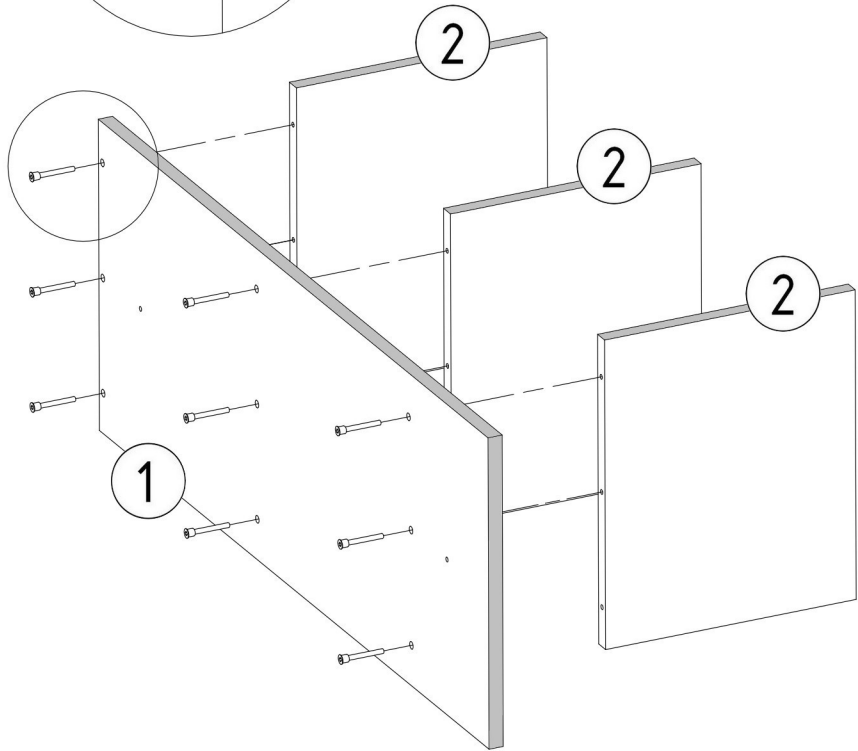
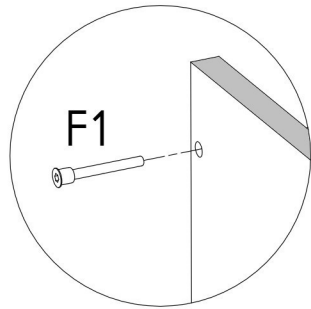
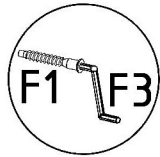
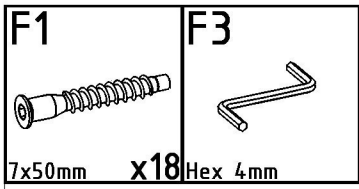

X2

V52



Ø=10mm X4

