

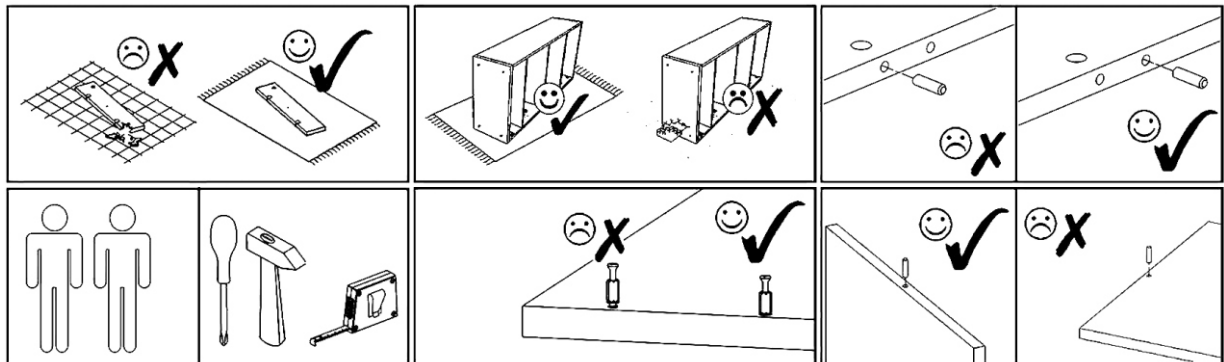

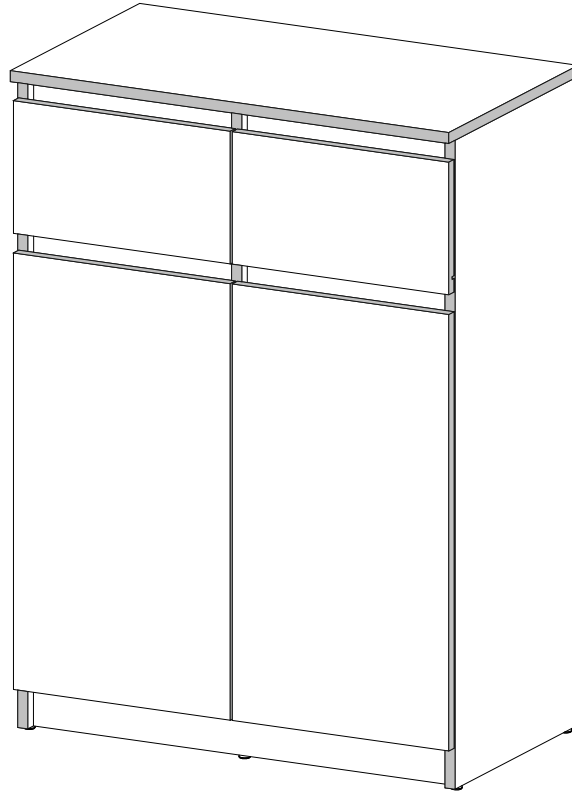







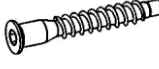
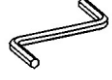



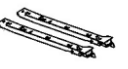

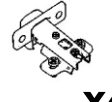
2DD2S

PRODUCTION DATE

PACKING CODE



E1  8x30mm x20	F1  7x50mm x6	F3  Hex 4mm x1	V16  5x16mm x8	N1  L=35mm x16	M1  12x15mm x16	T1  x5	P3  L=350mm x2
E3  8x50mm x4	A1  ZP x4	Z1  x70	R1  6x8mm x8	S1  3,5x16mm x16	B1  17/4mm ^B x4	V12  x1	V15  x10
V13  x1							

2DD2S





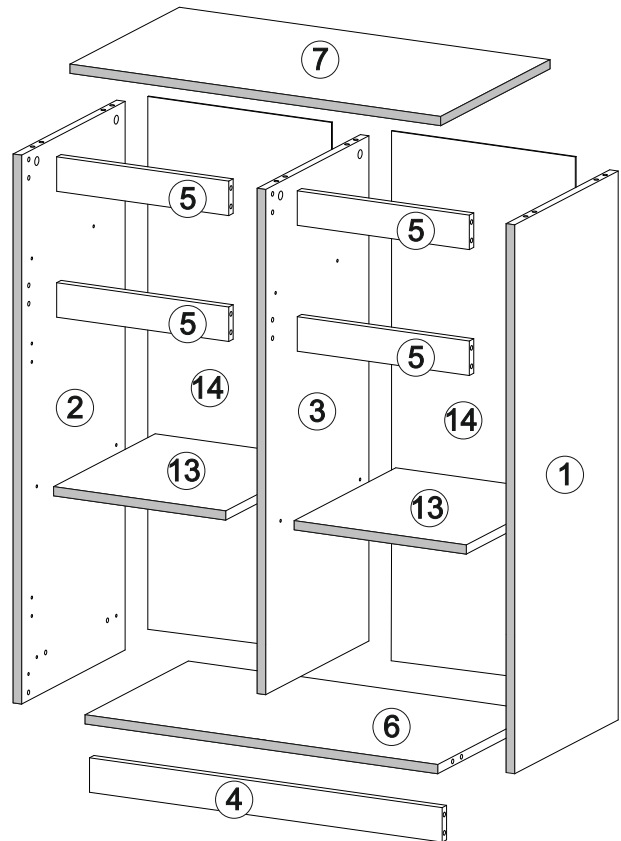
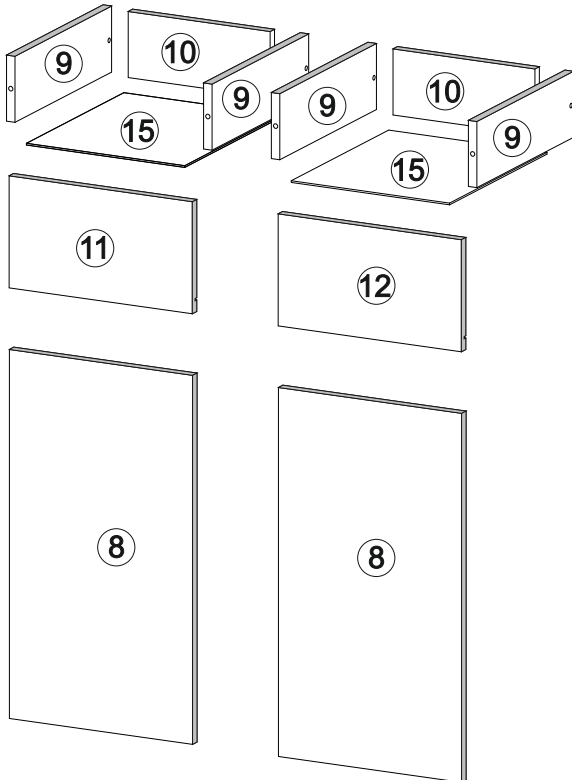

PRODUCTION DATE

PACKING CODE







001875	1	1
001874	2	1
001876	3	1
000145	4	1
000041	5	4
001878	6	1
001877	7	1
001879	8	2
000053	9	4
ID	NUMBER	QUANTITY

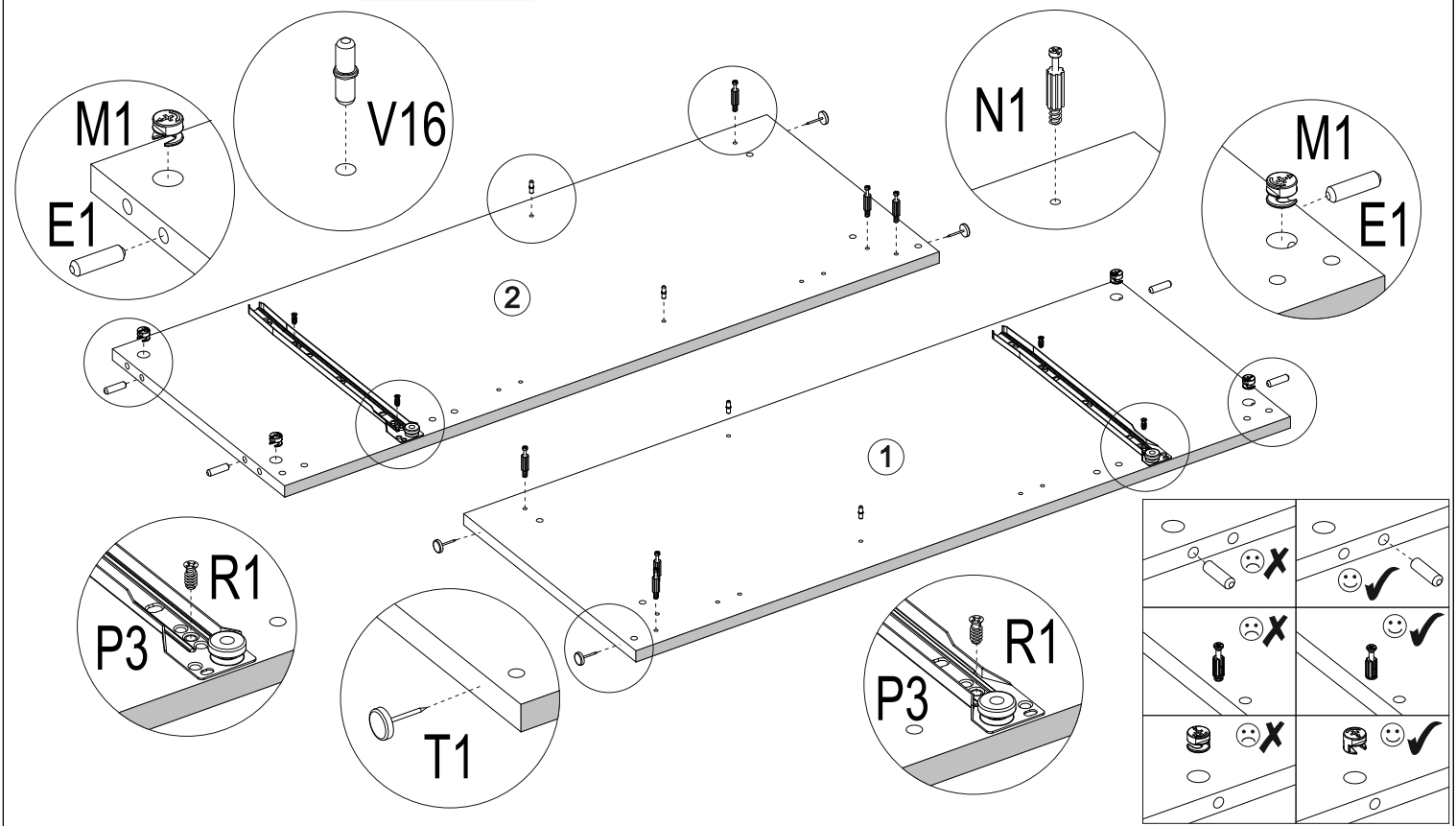



001930	10	2
001880	11	1
001929	12	1
000040	13	2
000371	14	2
001931	15	2

E1  8x30mm x4	N1  L=35mm x6	T1  x4	M1  12x15mm x4	P3  L=350mm x2	R1  6x8mm x4	V16  5x16mm x4
---	--	---	---	---	---	---

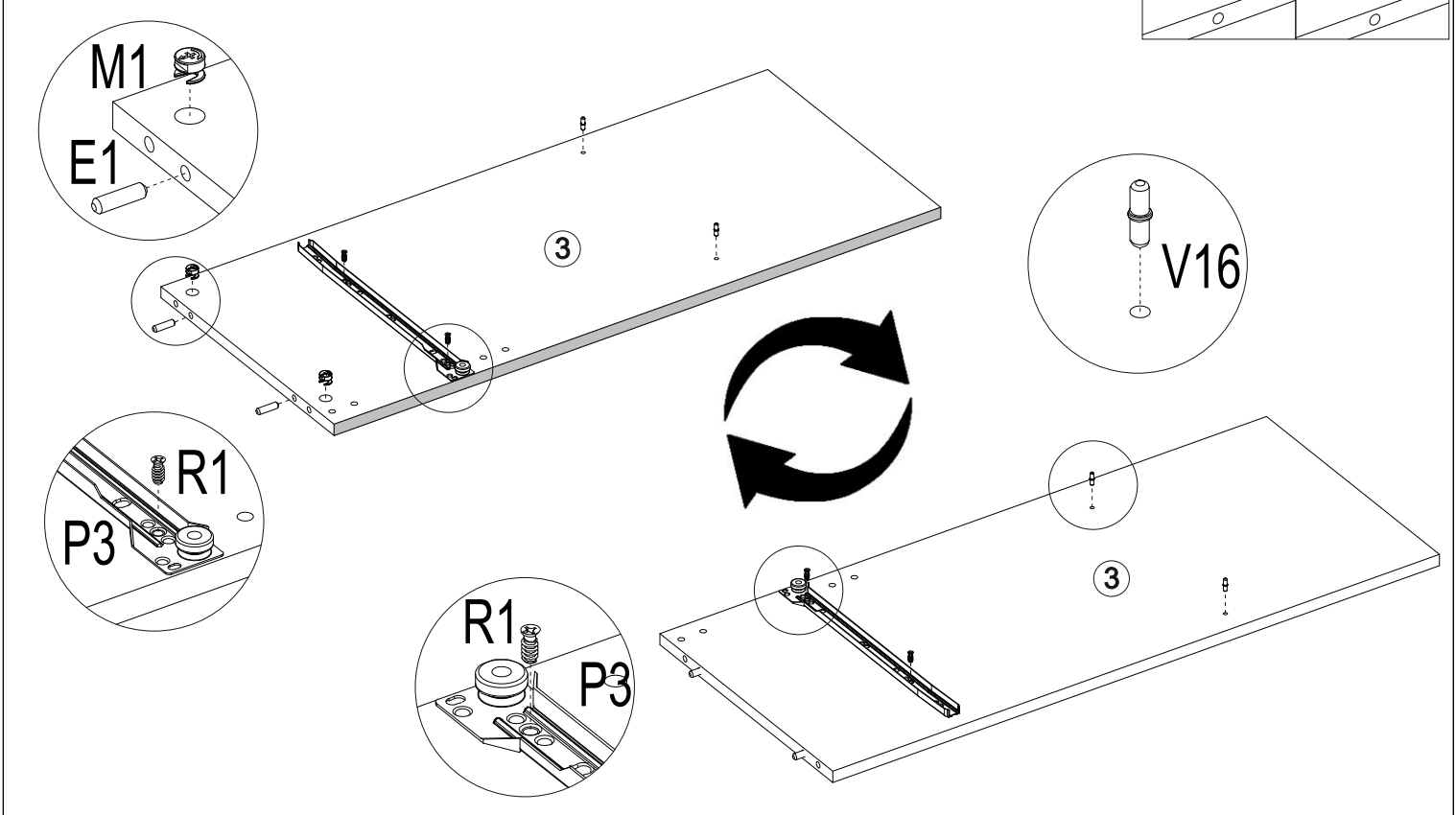
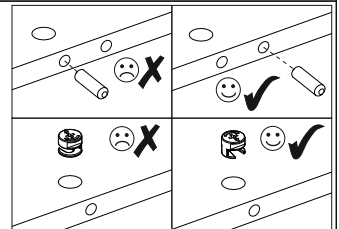

E1  8x30mm x2	V16  5x16mm x4	M1  12x15mm x2	P3  L=350mm x2	R1  6x8mm x4
---	---	---	---	---



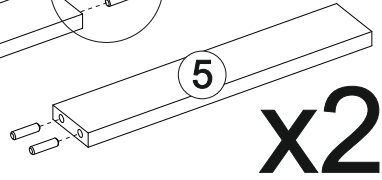
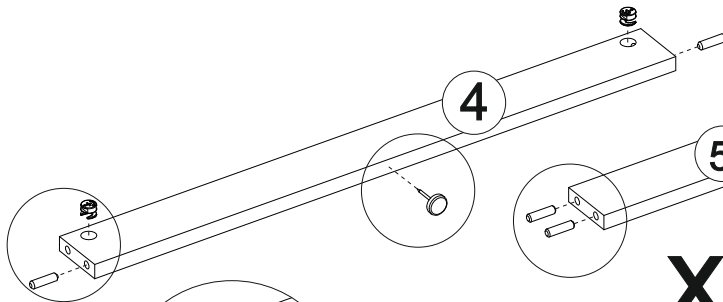
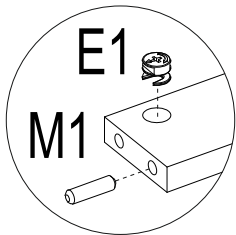
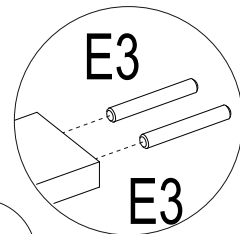
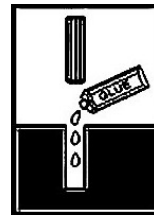

<p>M1</p>  <p>12x15mm x2</p>	<p>E1</p>  <p>8x30mm x10</p>	<p>E3</p>  <p>8x50mm x4</p>	<p>V12</p>  <p>x1</p>	<p>T1</p>  <p>x1</p>
---	---	--	--	---



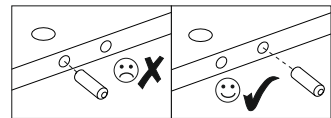
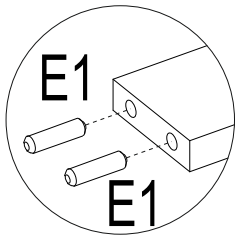
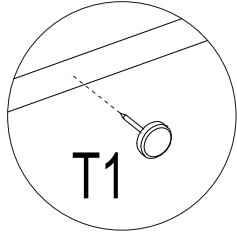

x2

x2

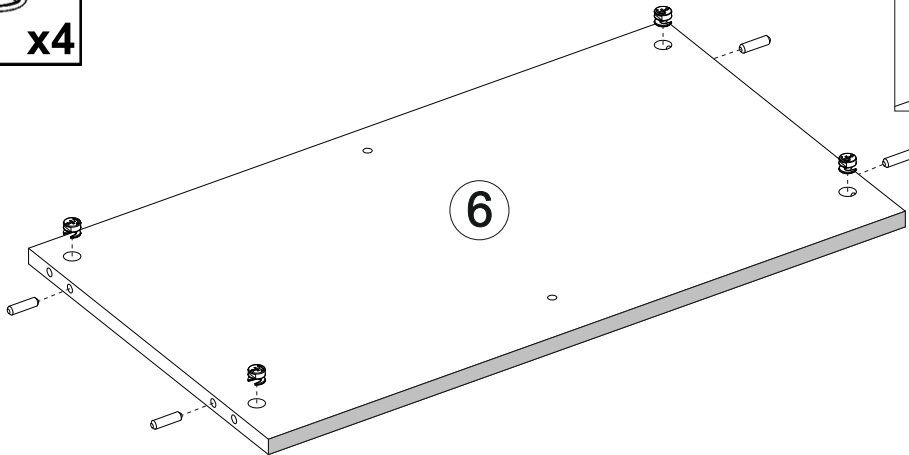
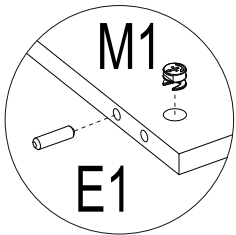
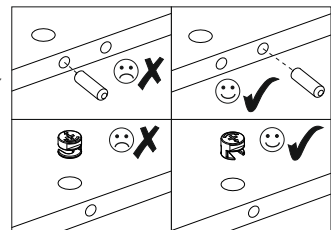

<p>E1</p>  <p>8x30mm x4</p>	<p>M1</p>  <p>12x15mm x4</p>
---	---



<p>N1</p>  <p>L=35mm x6</p>

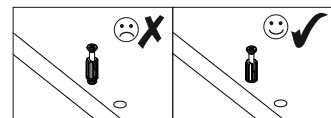
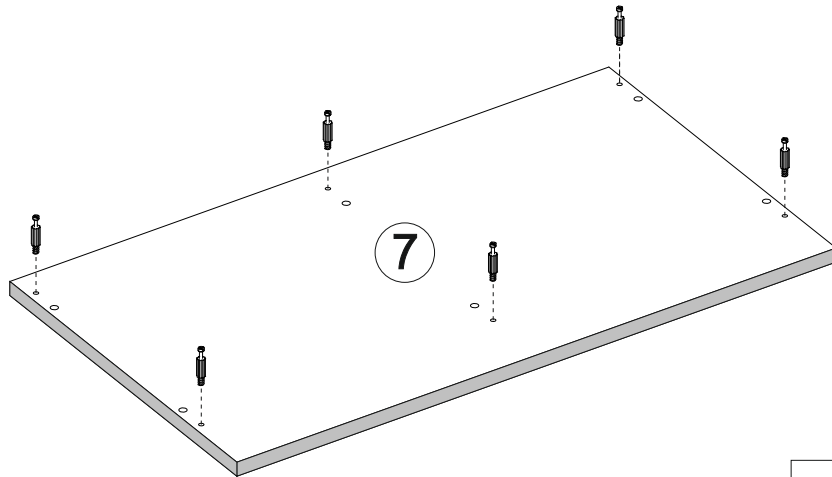
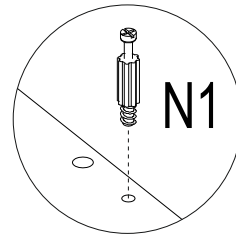

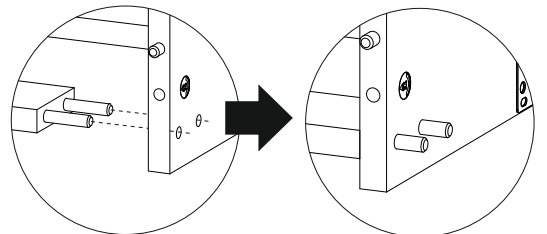
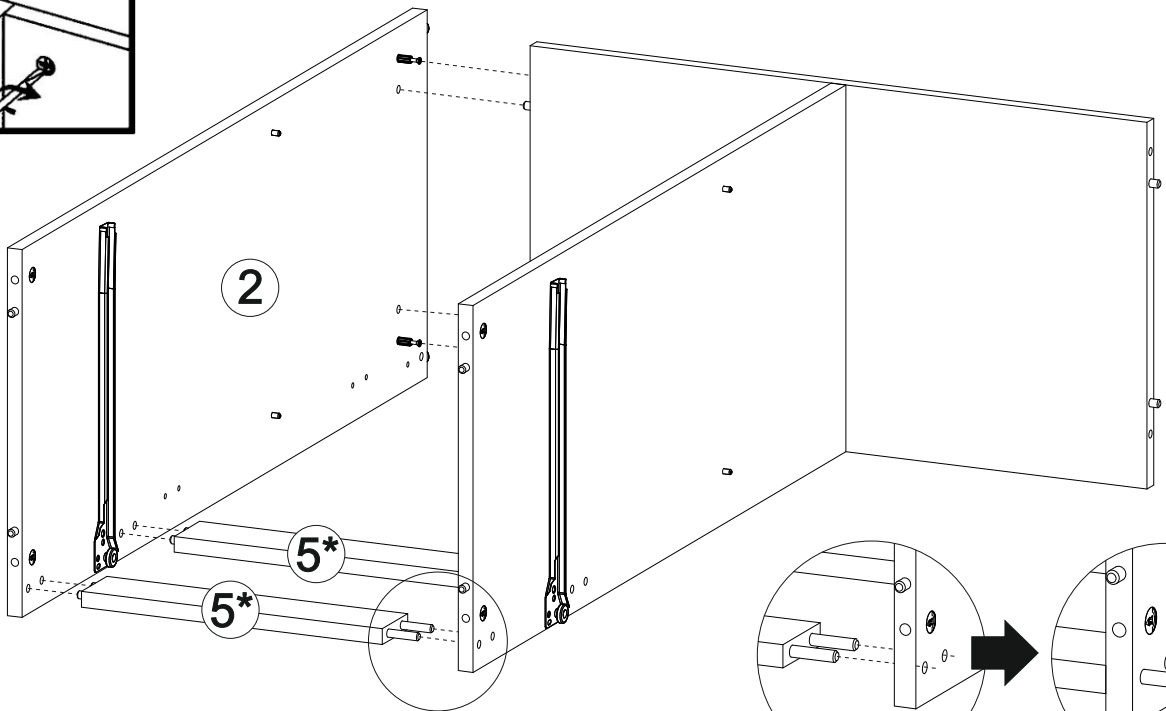
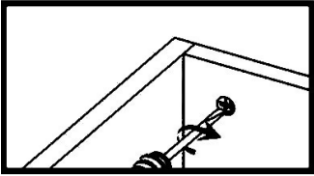
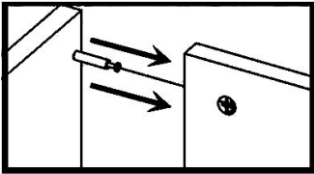
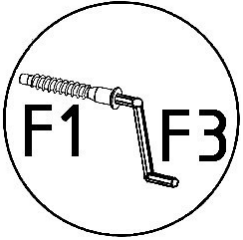
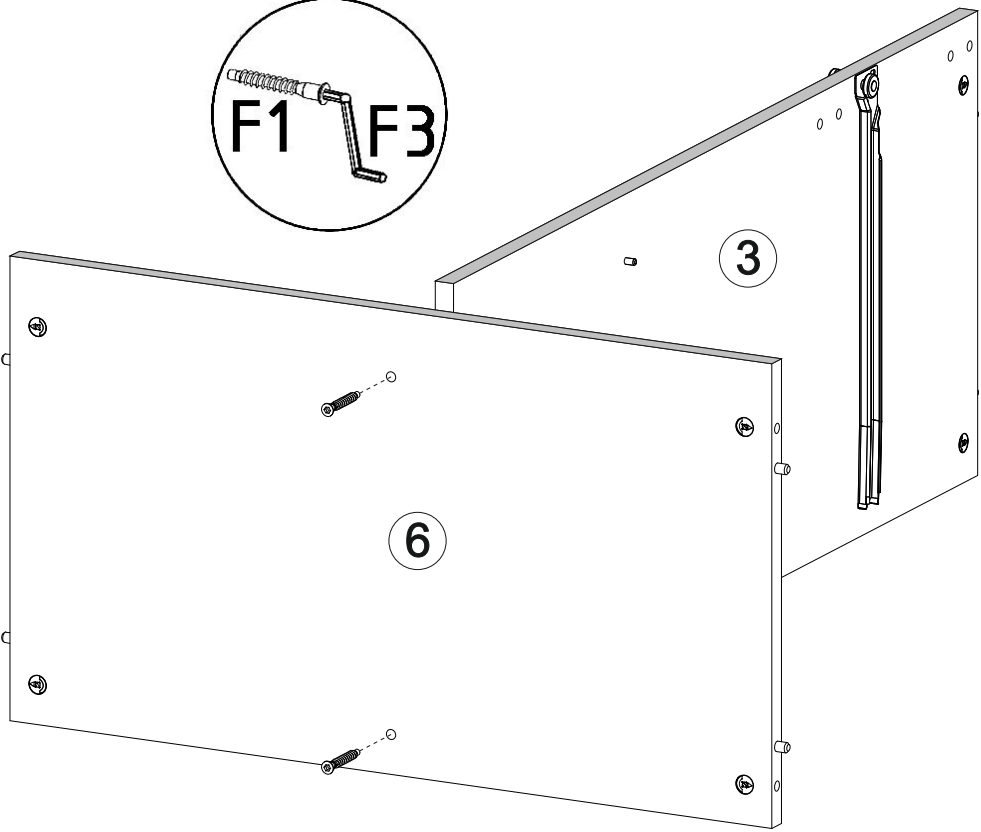
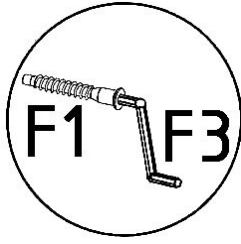
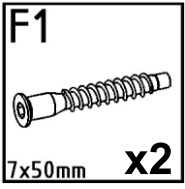

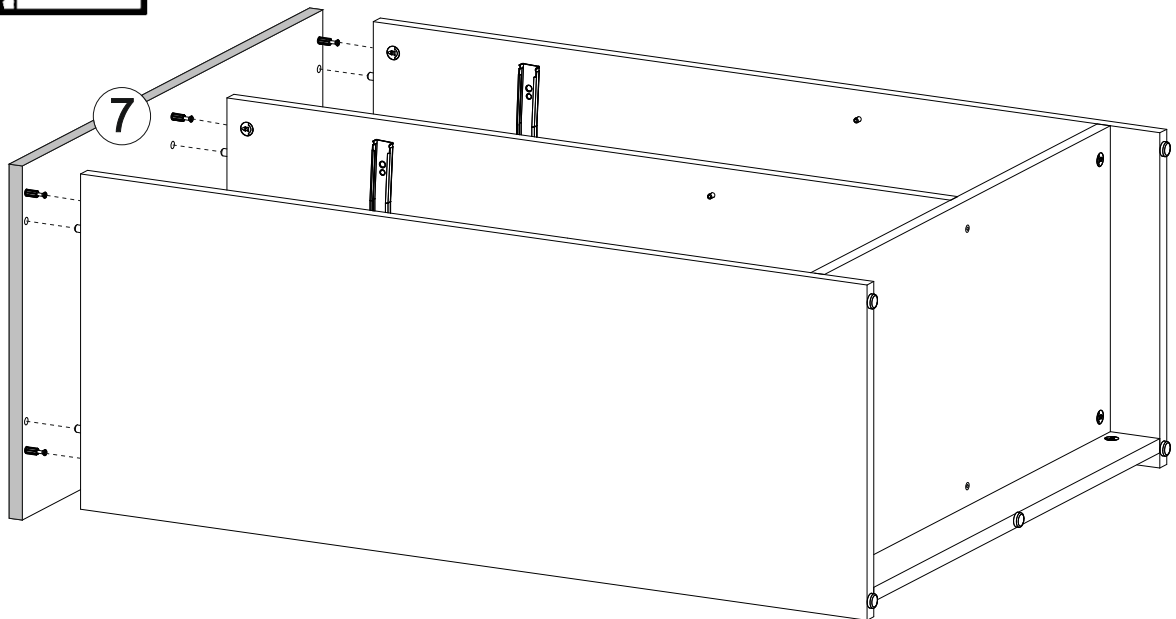
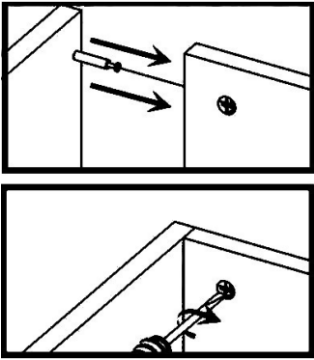
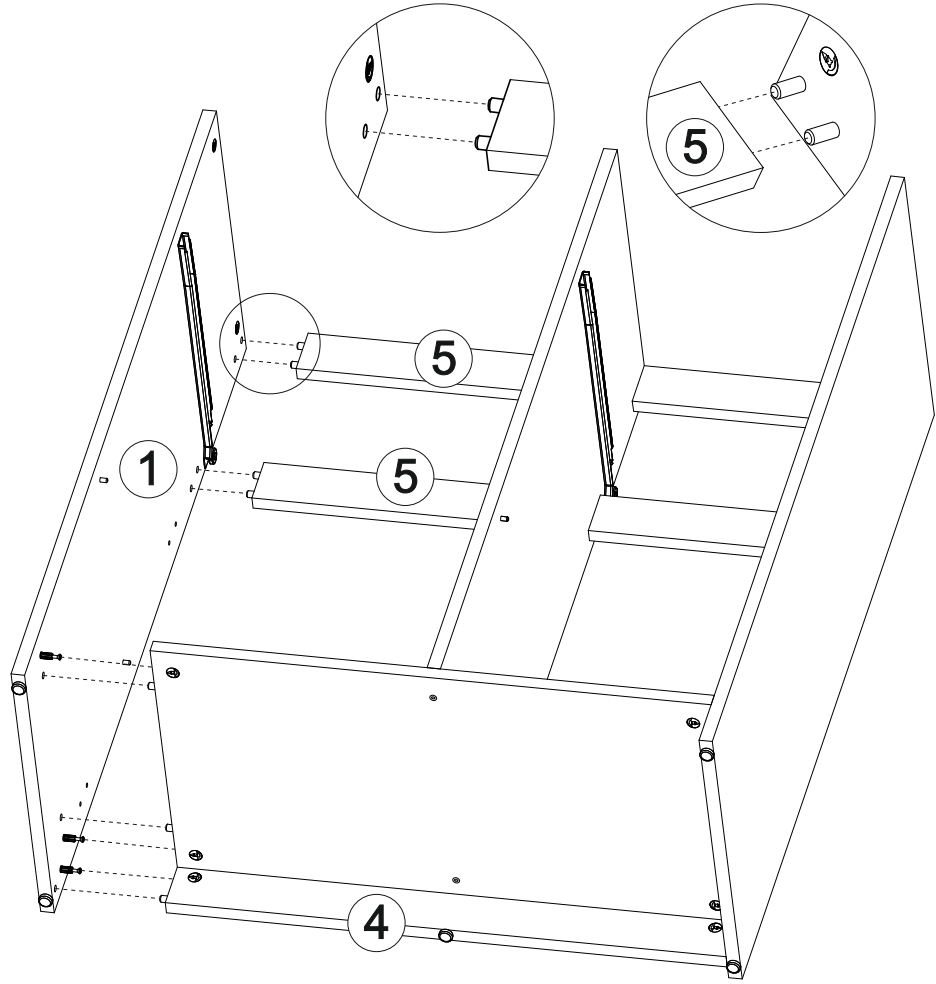
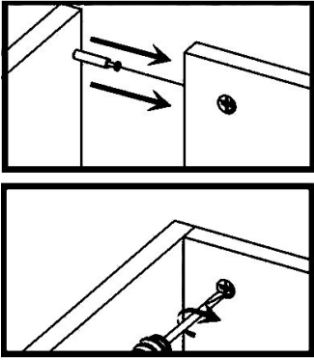

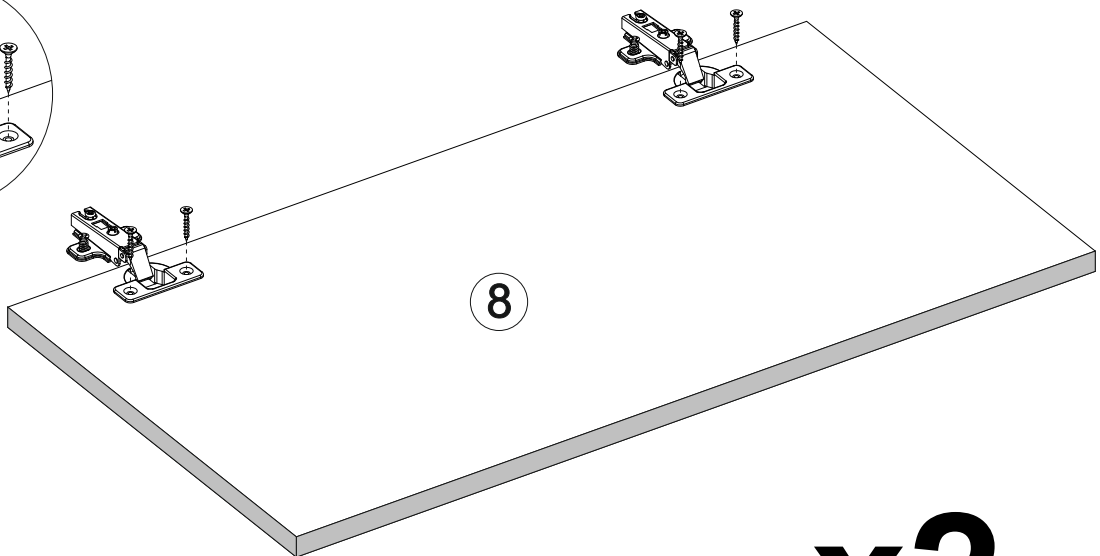
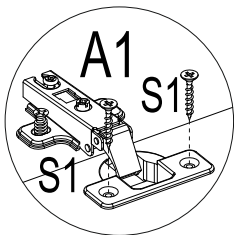
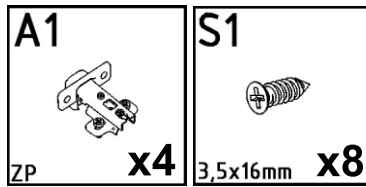
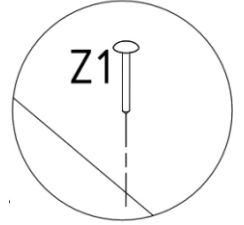
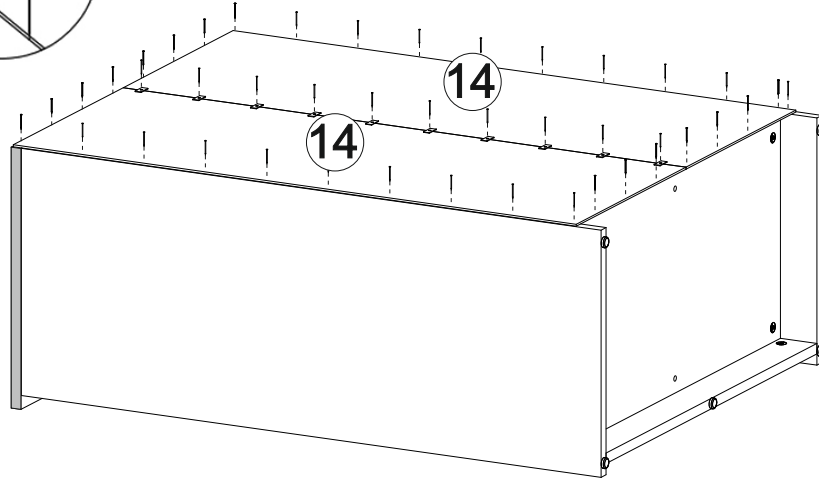
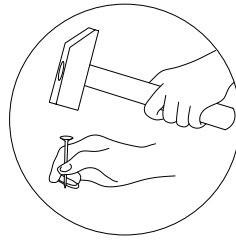
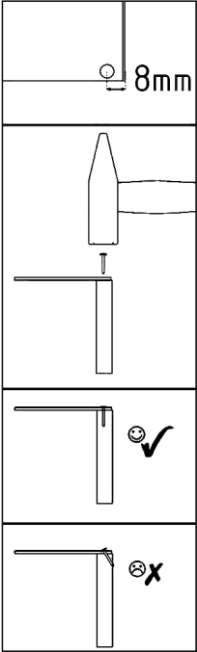
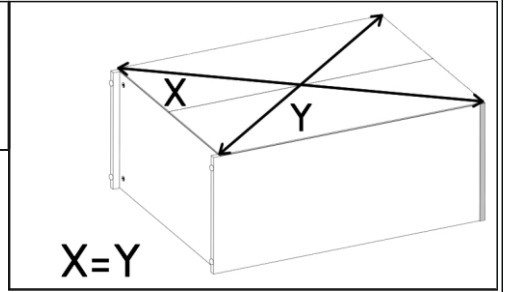
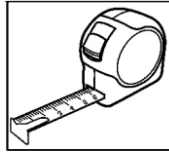
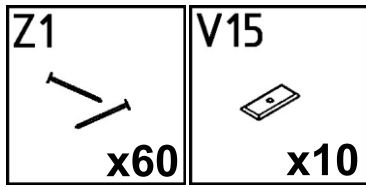

x2

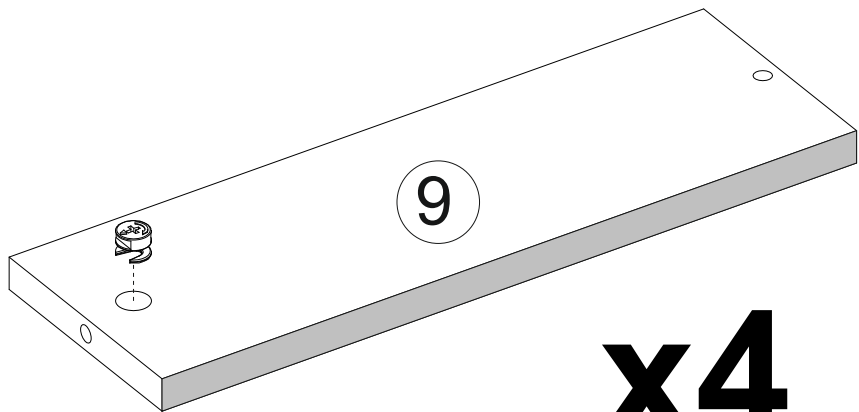
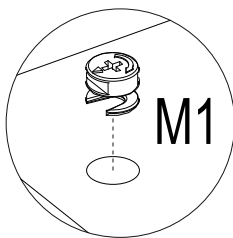
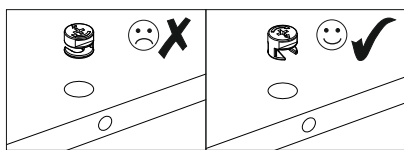
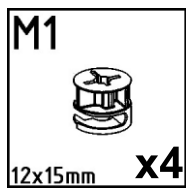
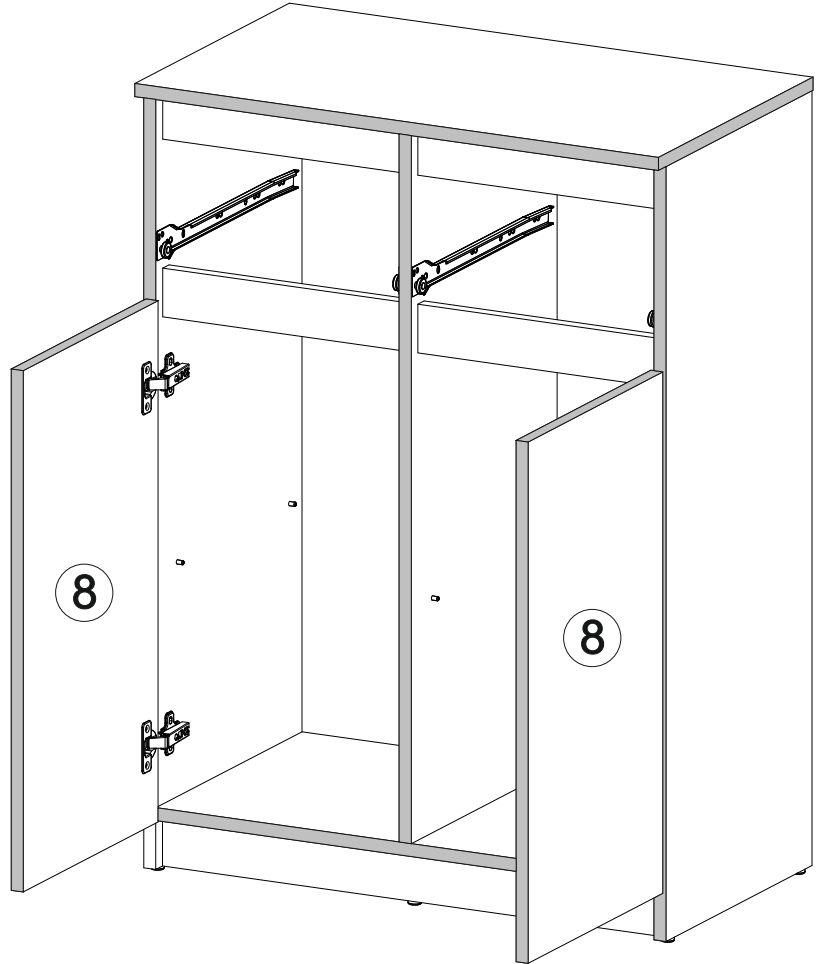
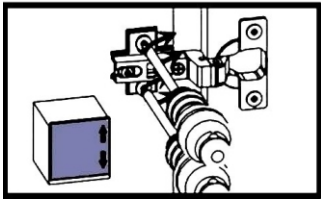
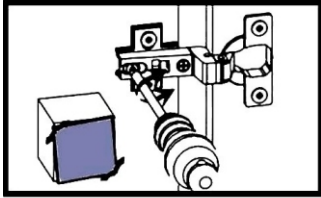
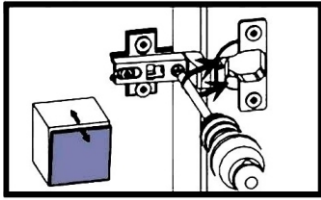
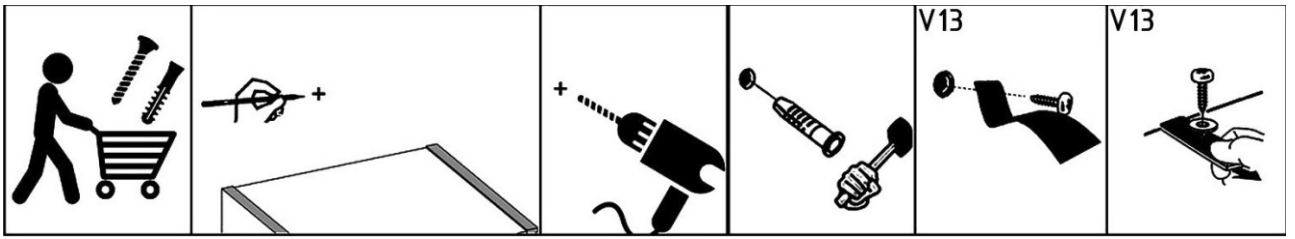

x4

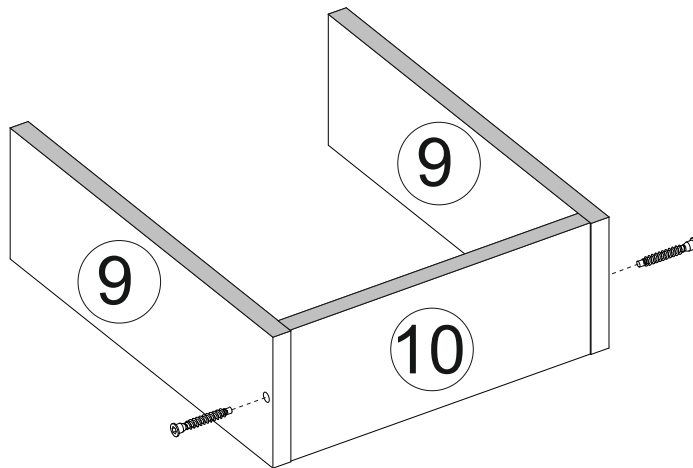
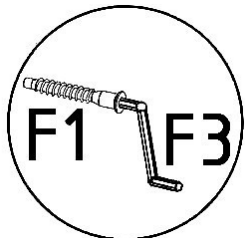
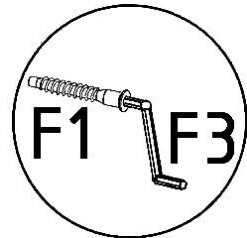
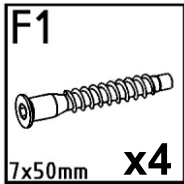

x2

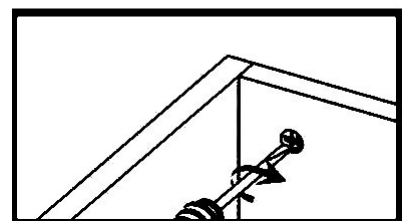
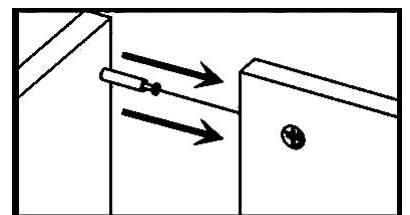
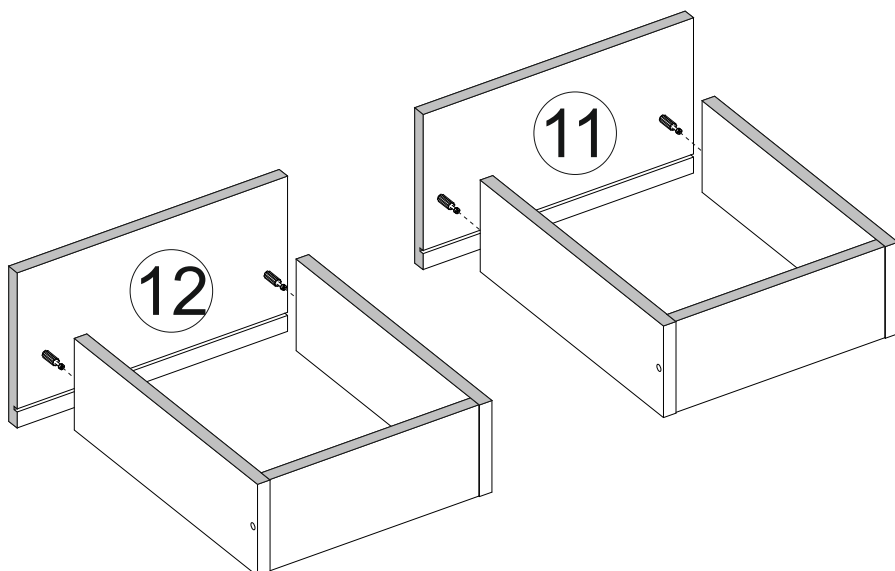
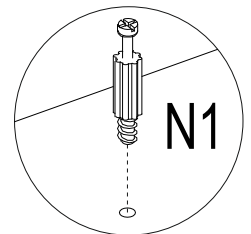
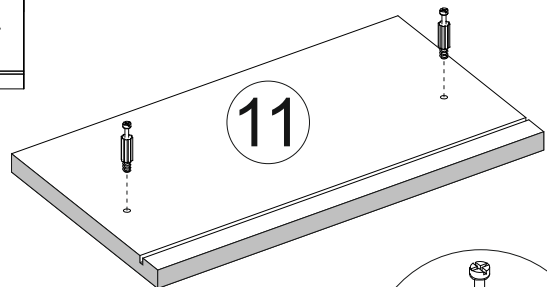
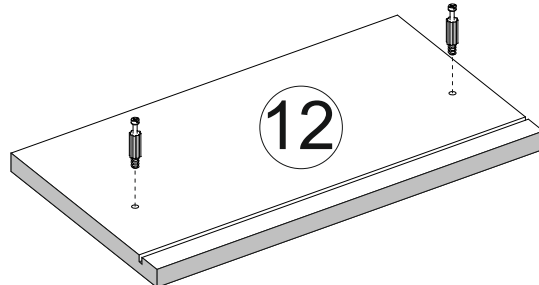
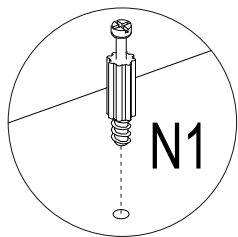
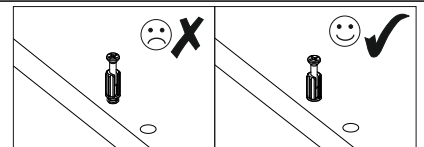
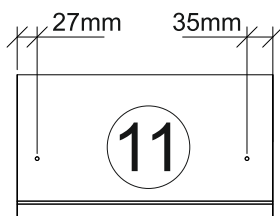
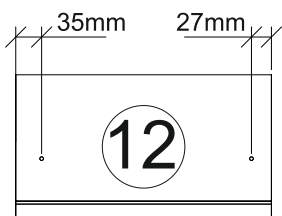
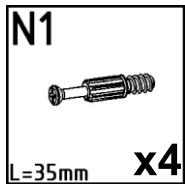

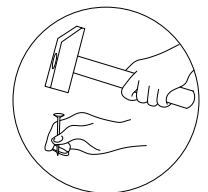
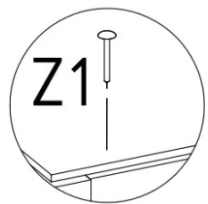
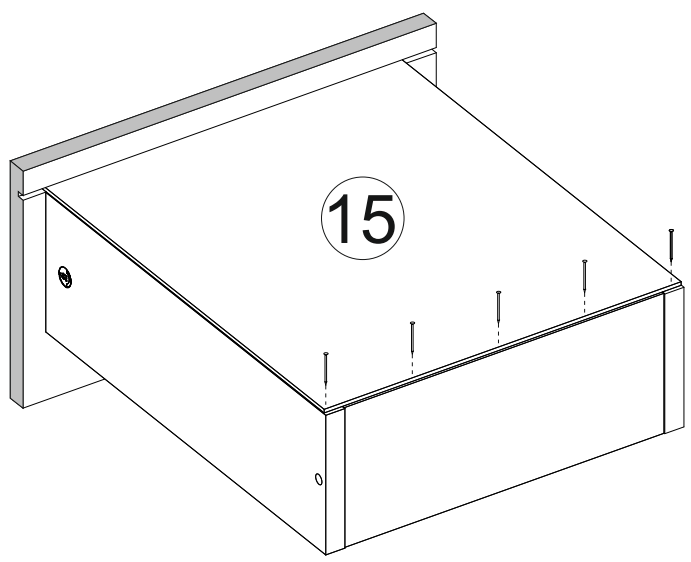
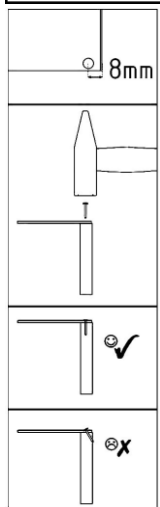
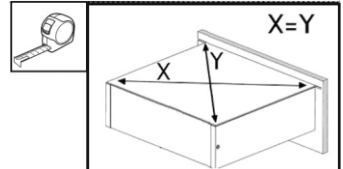
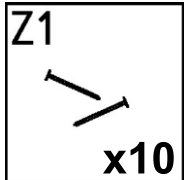

x2

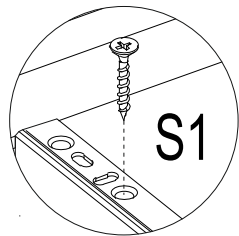
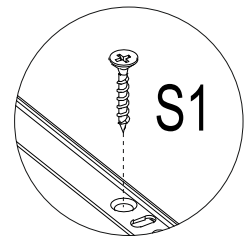
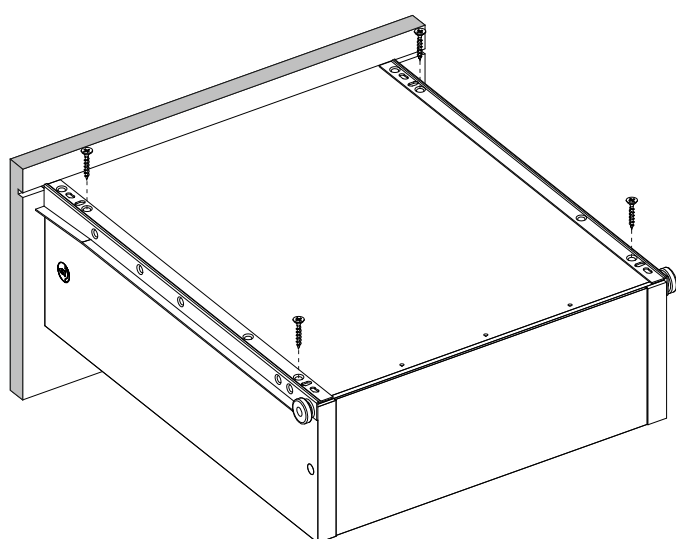
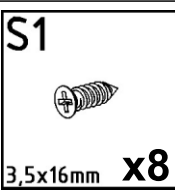
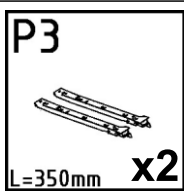

x2

