

MIJAS P

PRODUCTION DATE

PACKING CODE

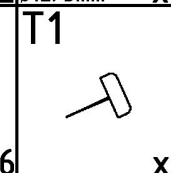

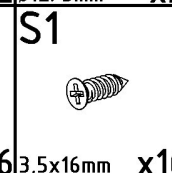
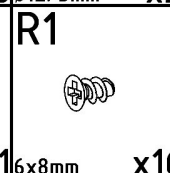
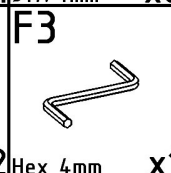
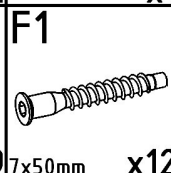
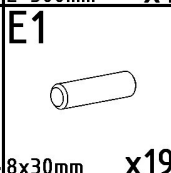
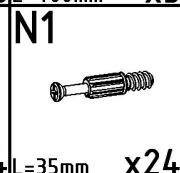
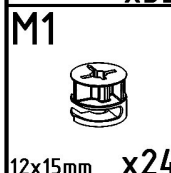
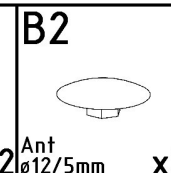
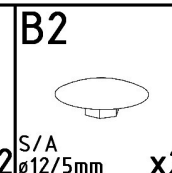
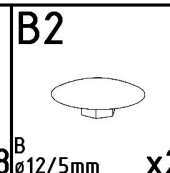
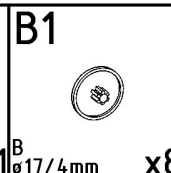
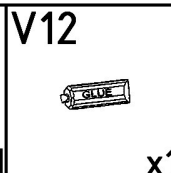
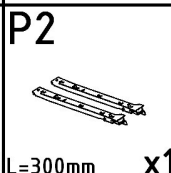
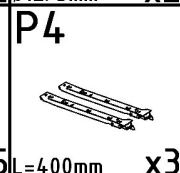
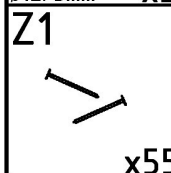
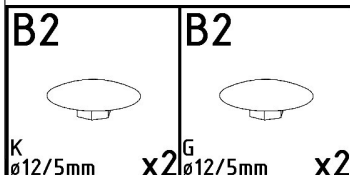
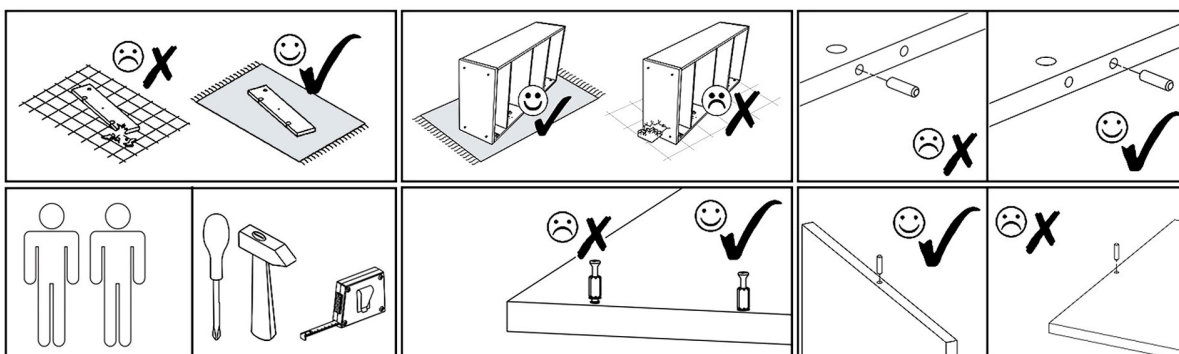
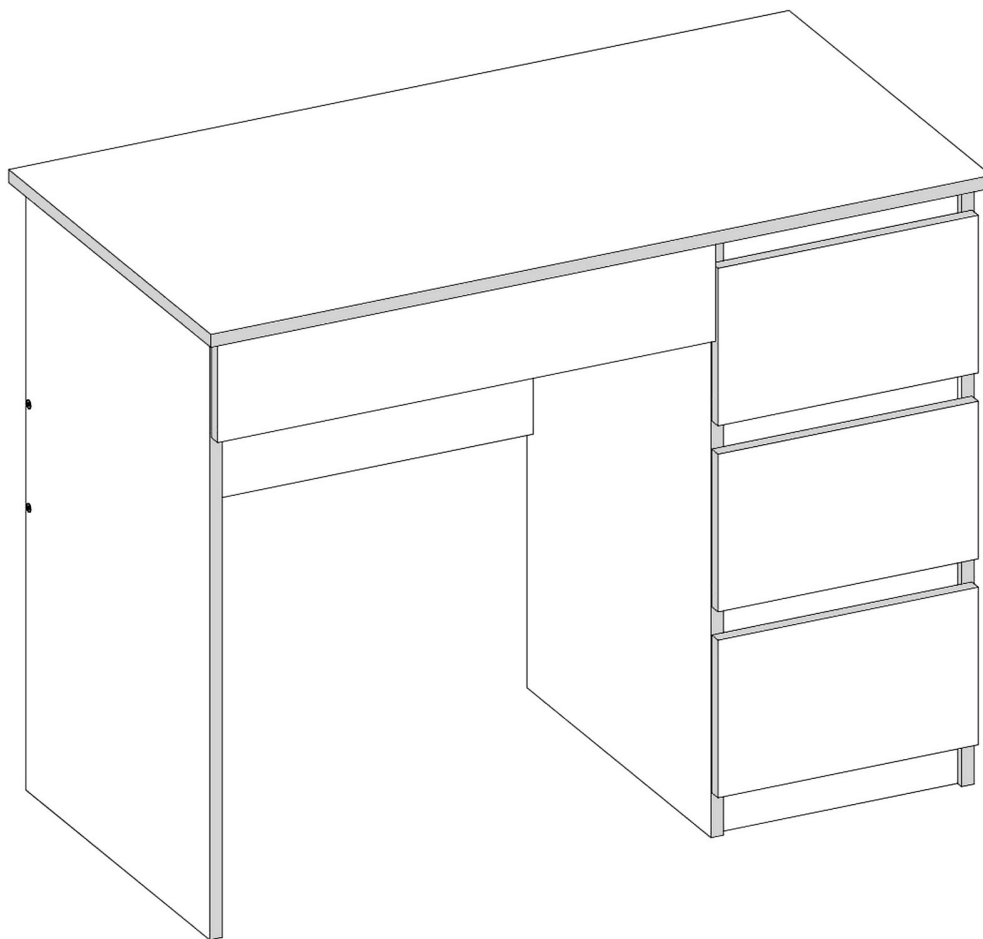



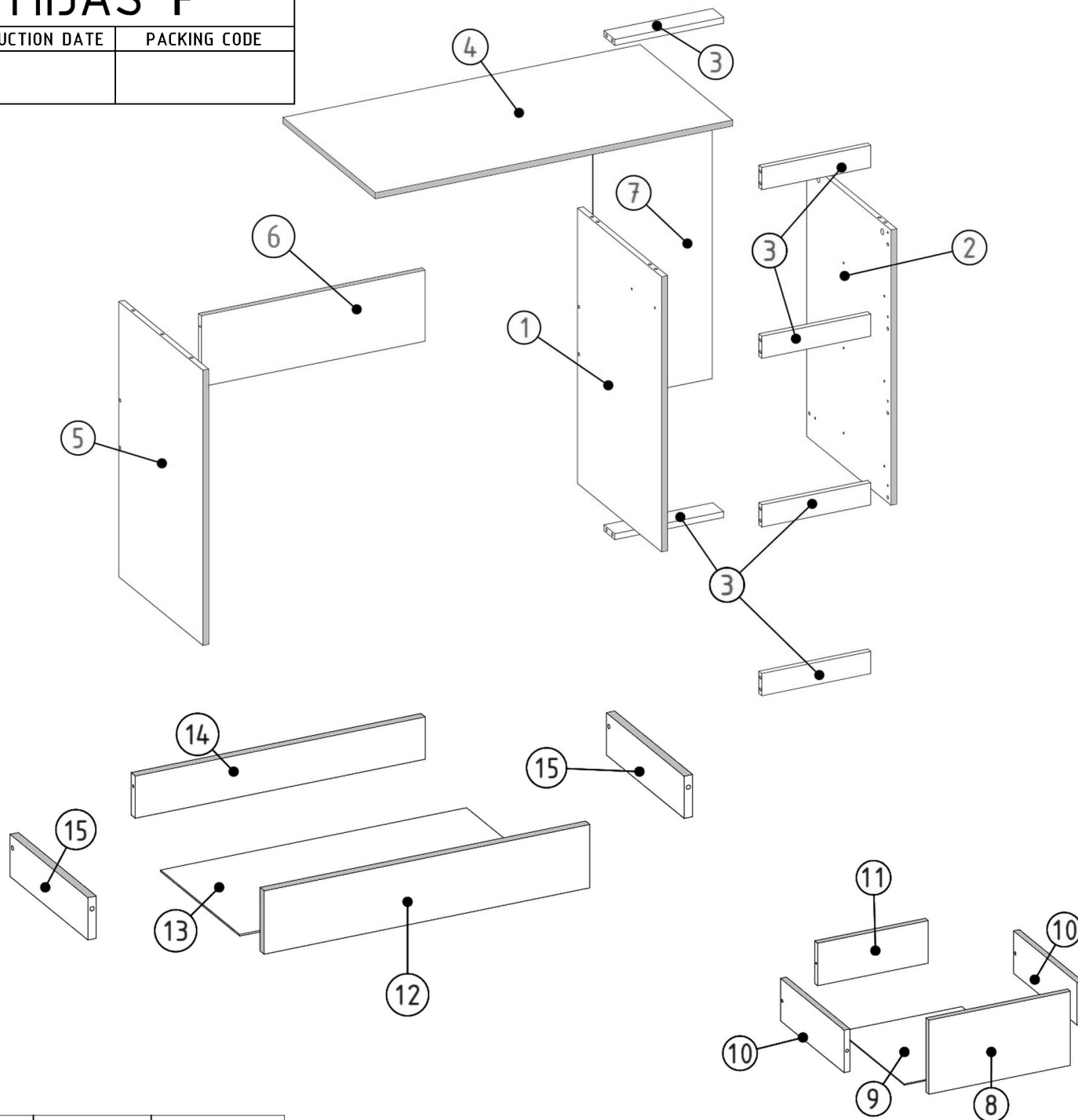

MIJAS P

PRODUCTION DATE







PACKING CODE

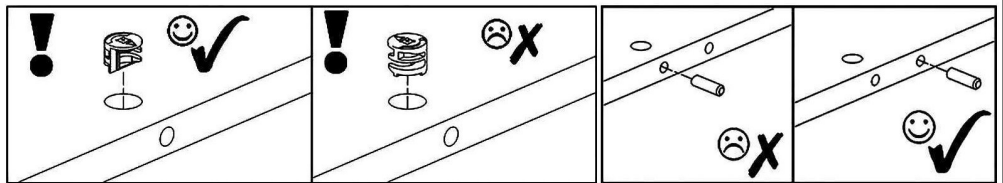
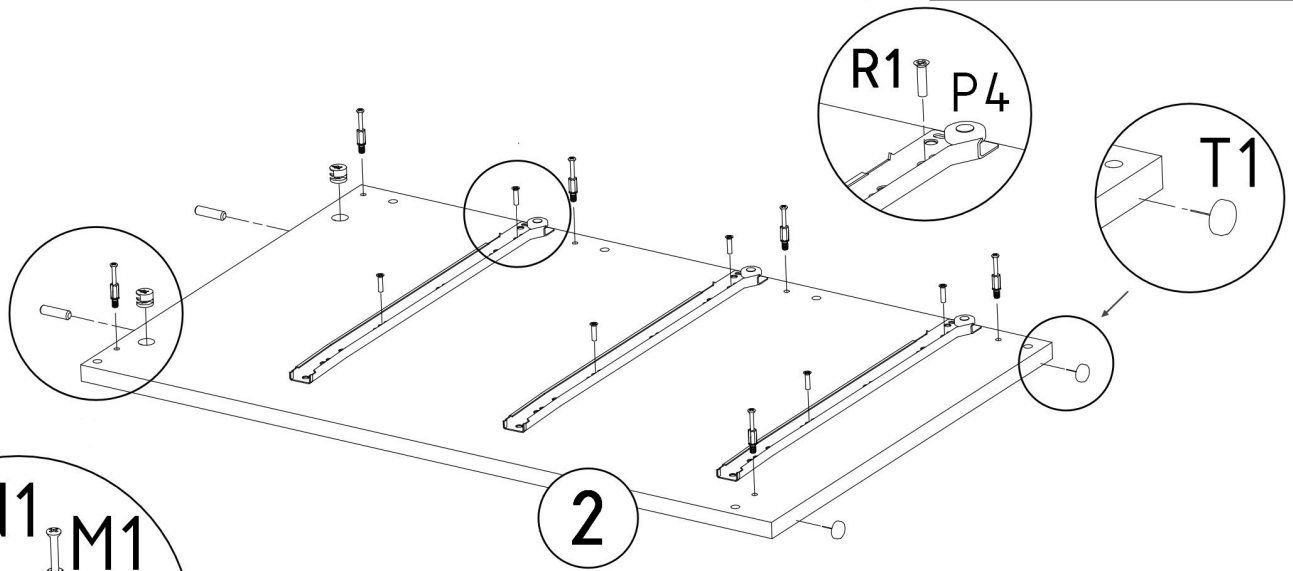
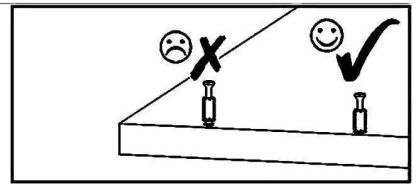



000032	15	2
000107	14	1
000034	13	1
000428	12	1
000007	11	3
000083	10	6
000021	9	3
000044	8	3
000147	7	1
000133	6	1
000430	5	1
000429	4	1
000030	3	6
000431	2	1
000432	1	1
ID	NUMBER	QUANTITY

N1  L=35mm	M1  12x15mm	E1  8x30mm	R1  6x8mm	P4  L=400mm	T1  x3
x6	x2	x2	x6	x3	x2



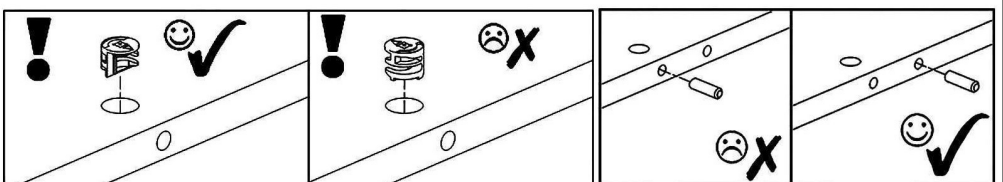
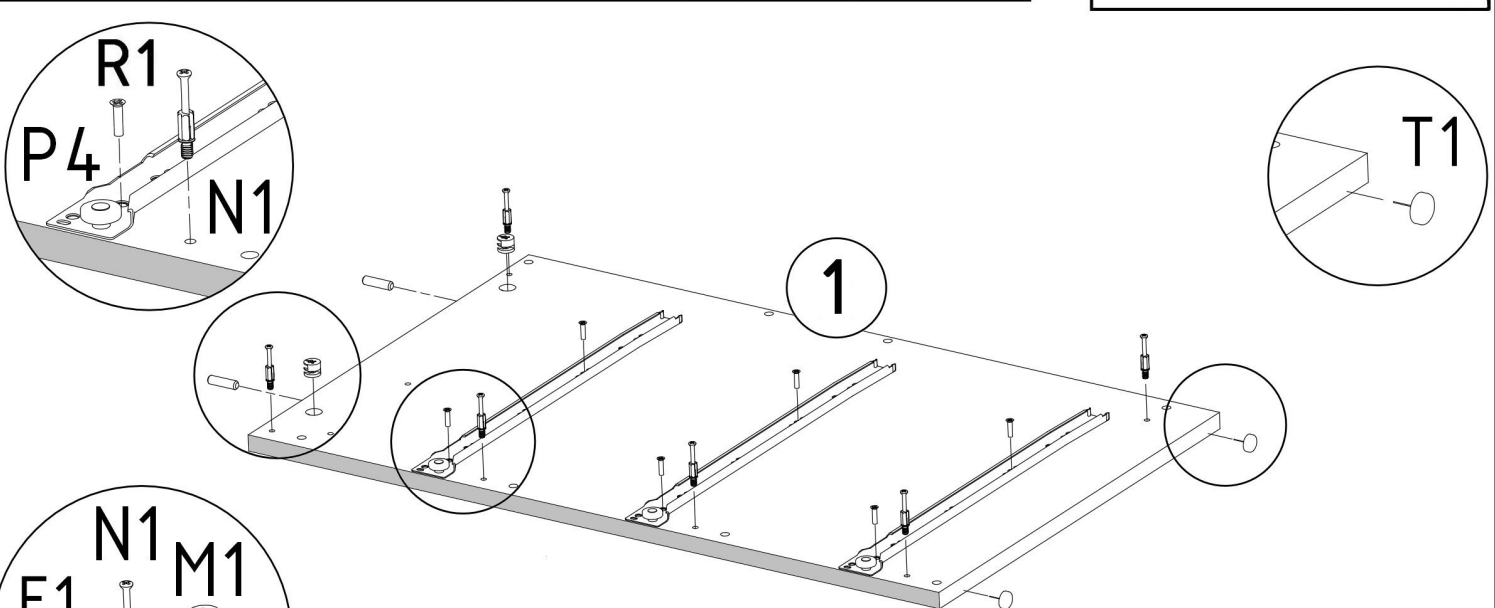
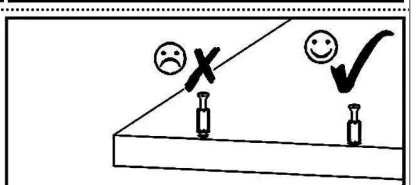

N1  L=35mm	M1  12x15mm	E1  8x30mm	R1  6x8mm	P4  L=400mm	T1  x3
x6	x2	x2	x6	x3	x2

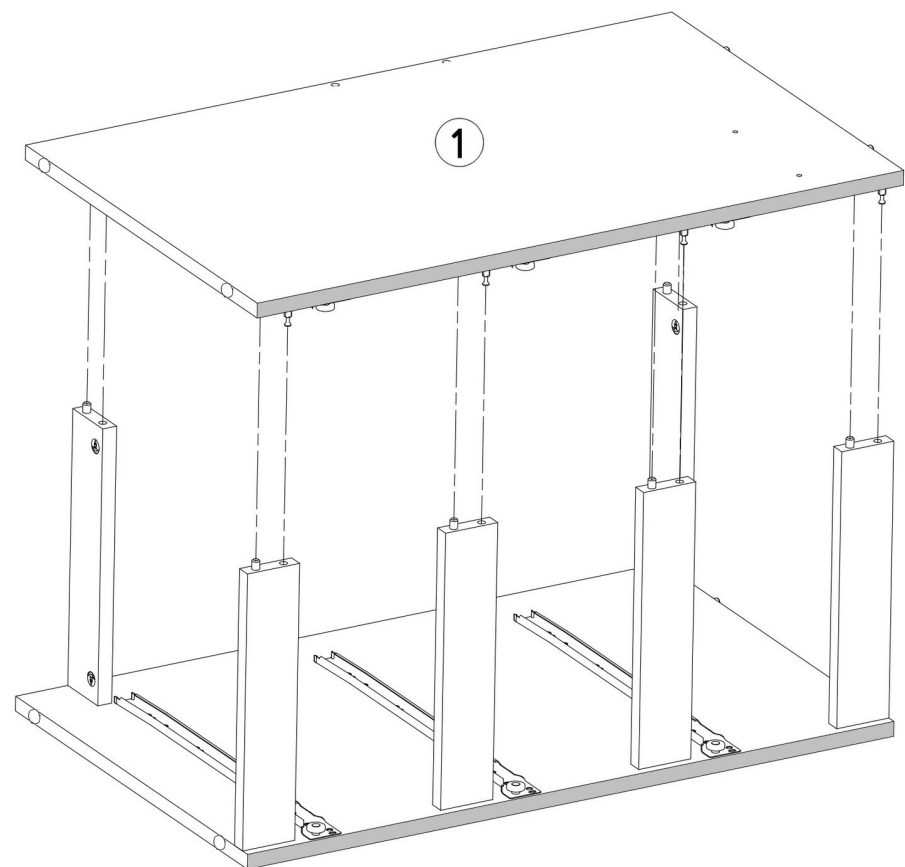
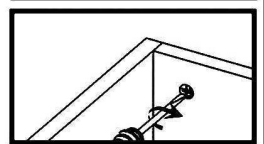
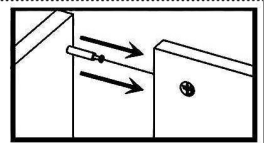
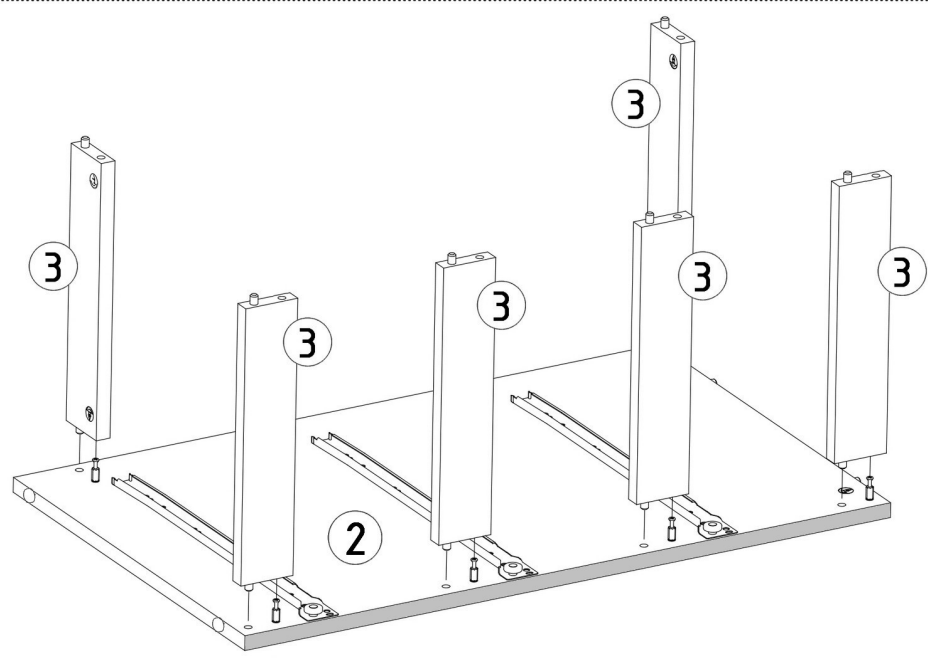
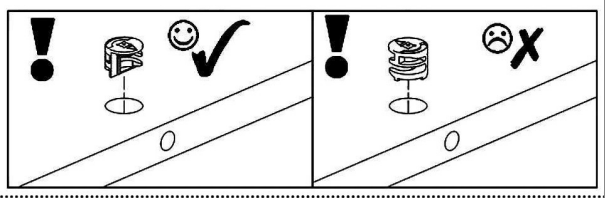
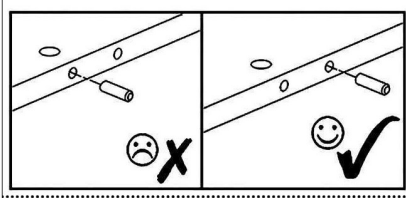
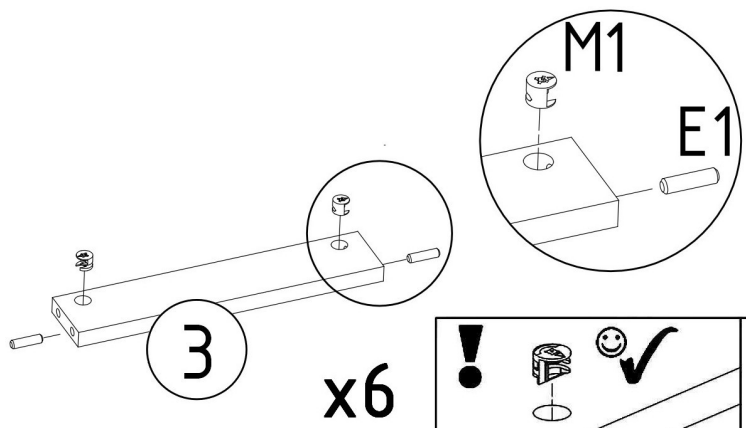

E1  8x30mm x12	M1  12x15mm x12
---	--



E1  8x30mm x3	T1  x2	V12  x2
--	--	---

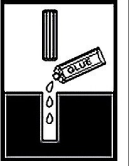
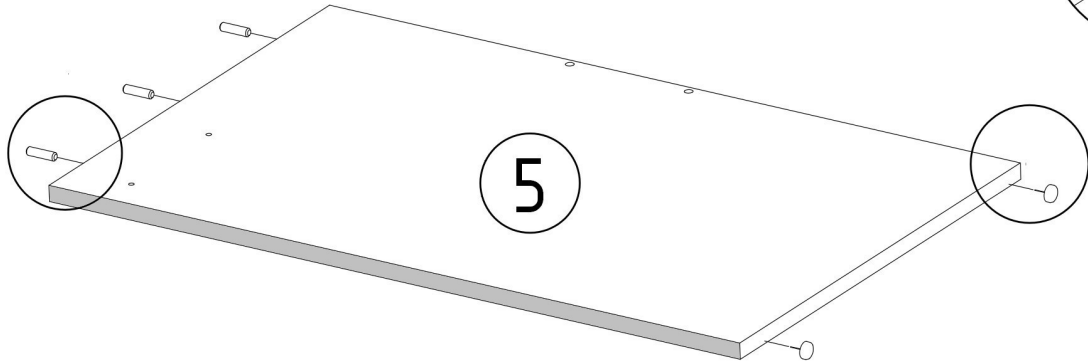
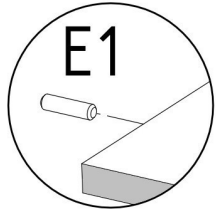
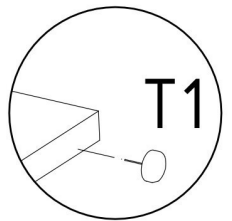

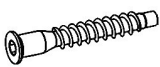
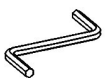
F1  7x50mm x4	F3  Hex 4mm
--	--

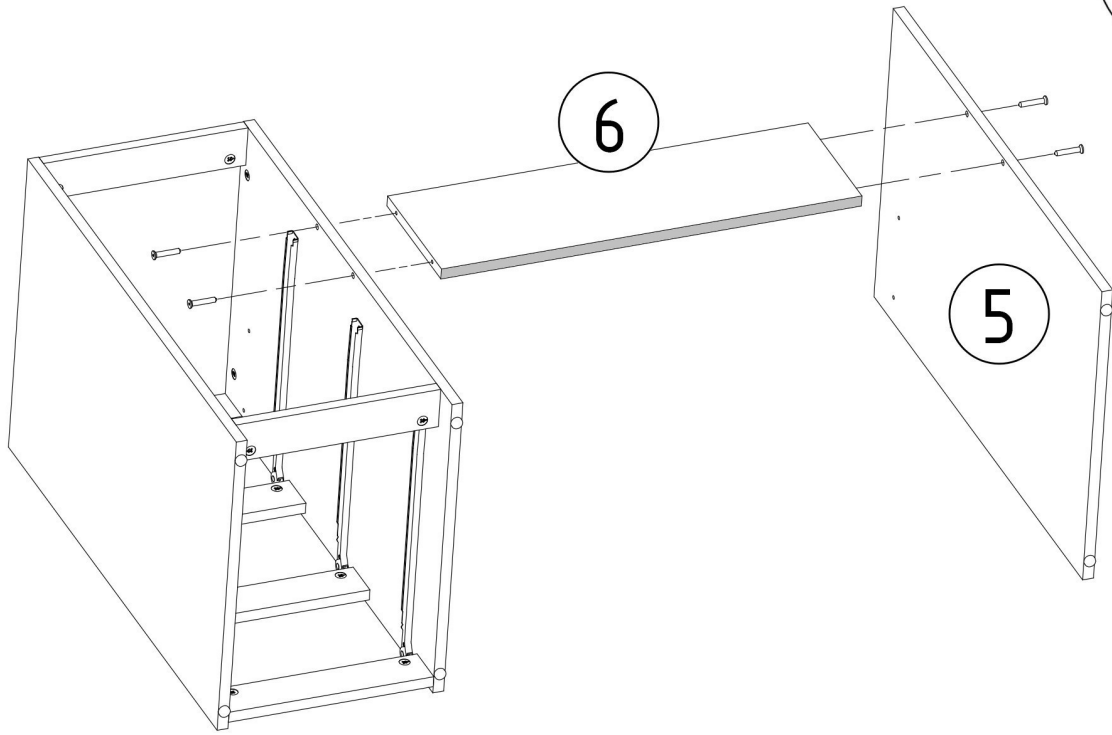
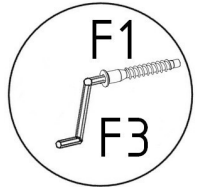

N1



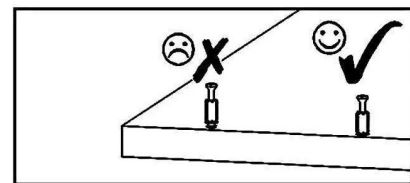
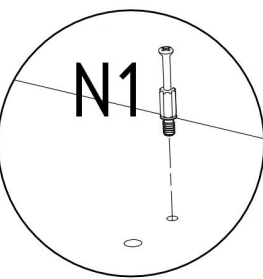
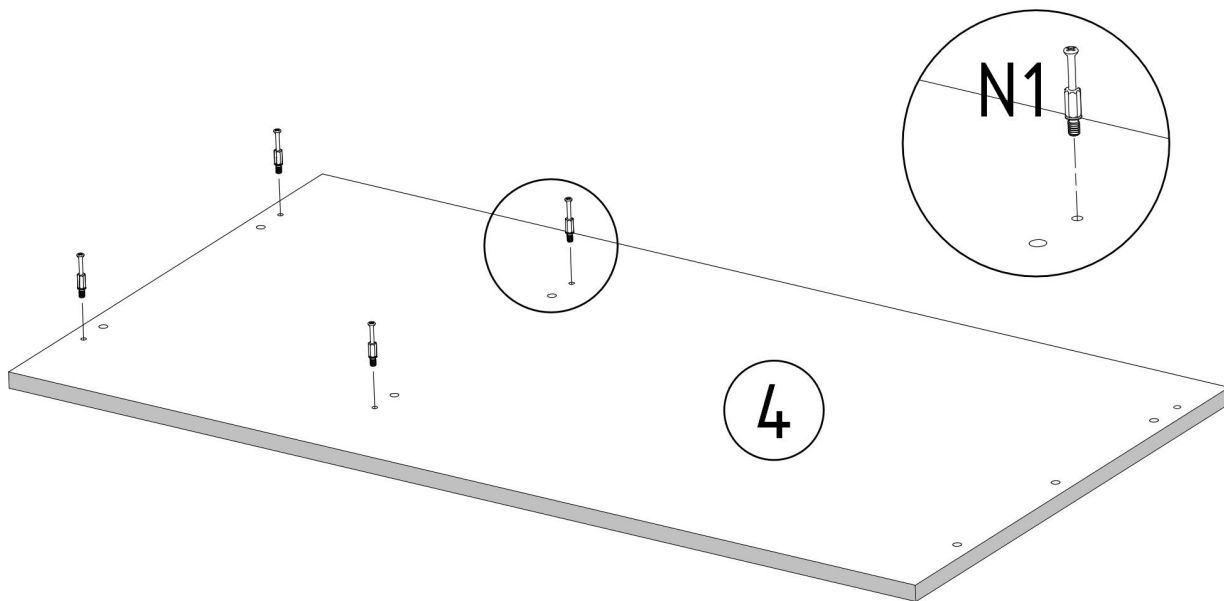

L=35mm X4

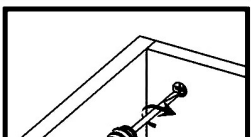
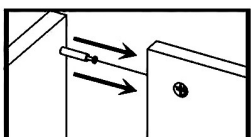
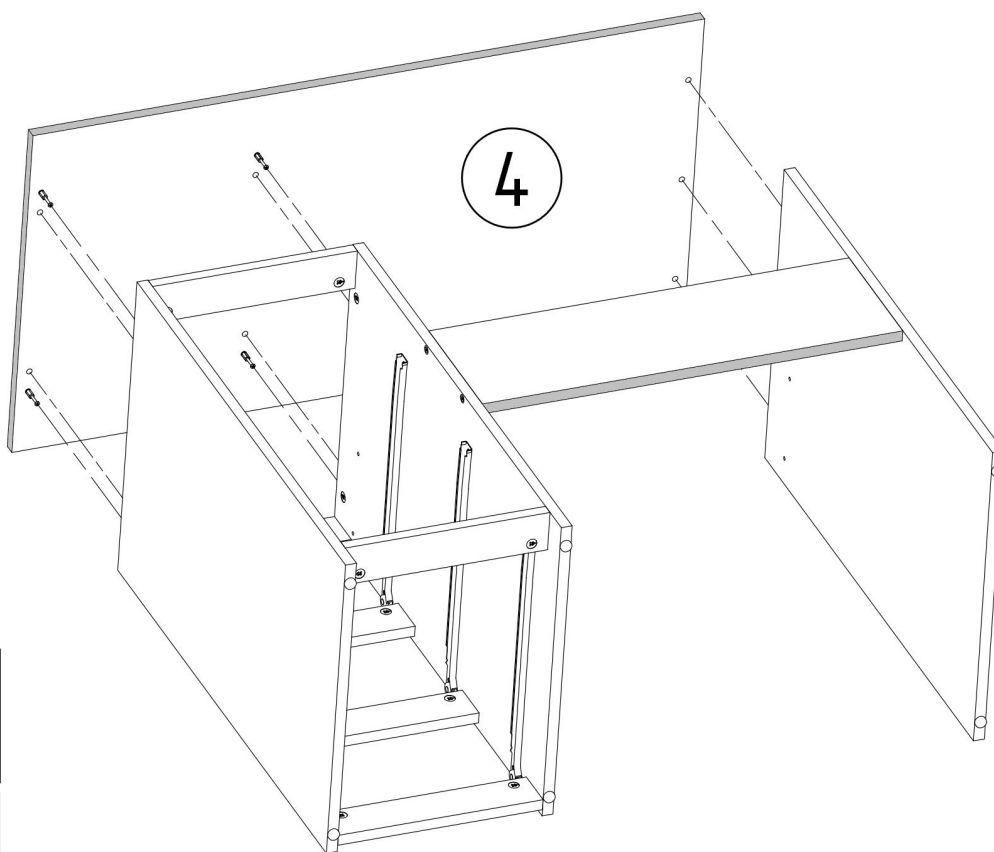
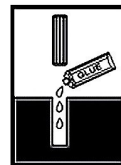

V12

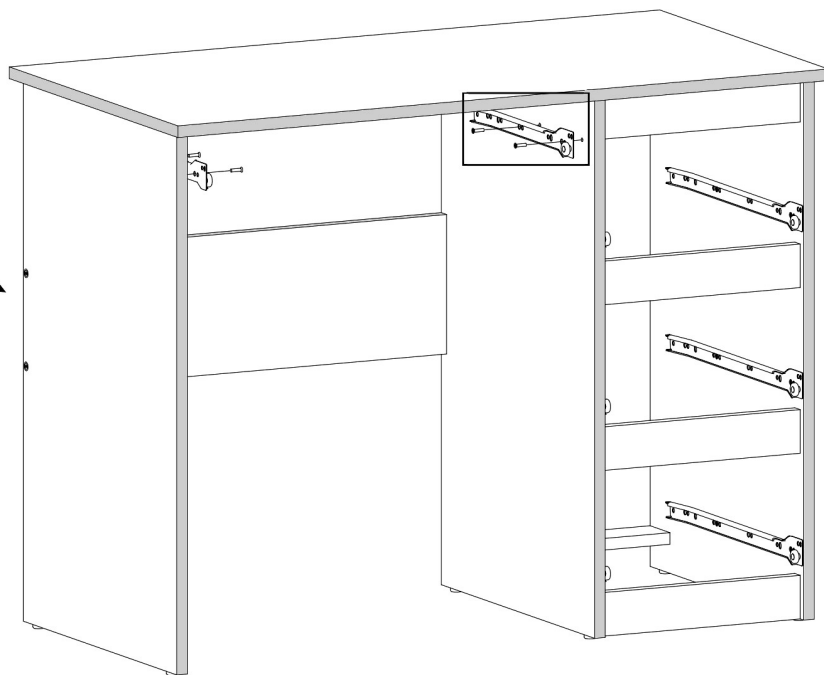
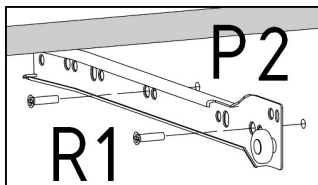
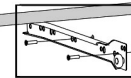
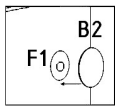
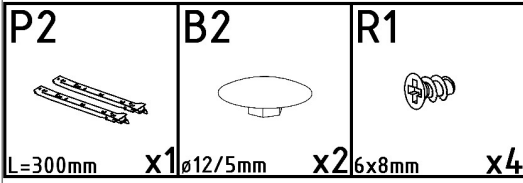
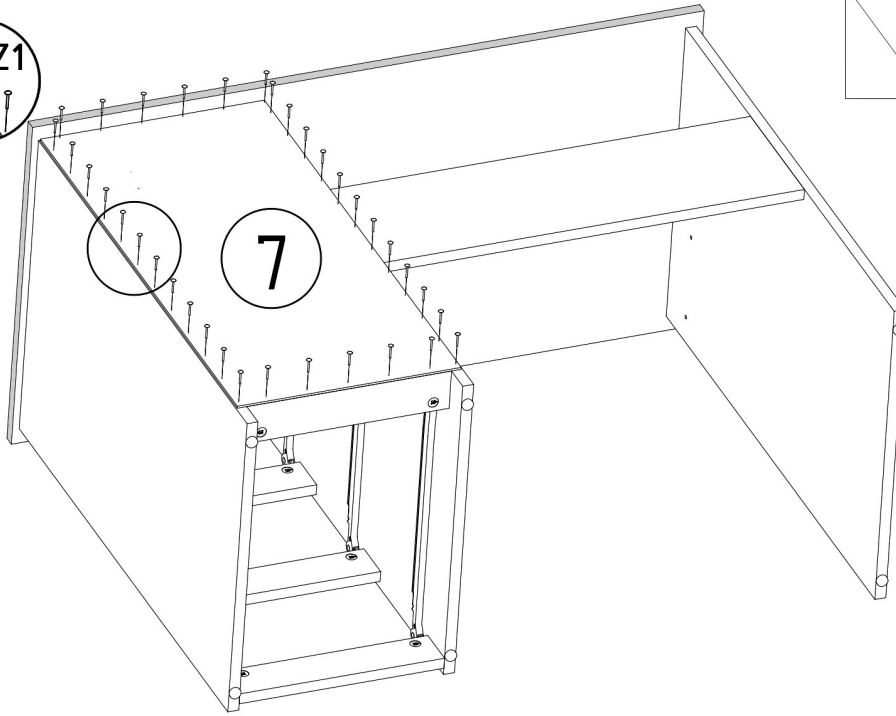
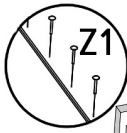
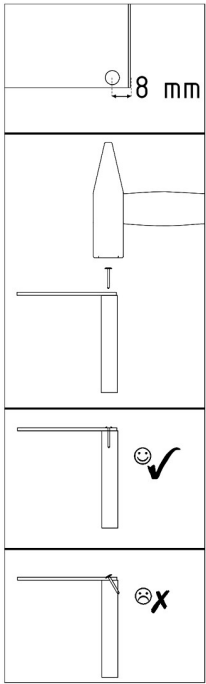
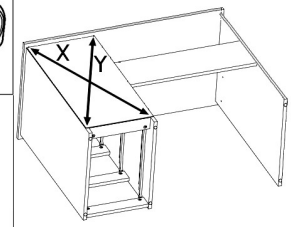
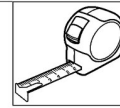
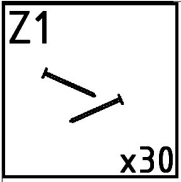

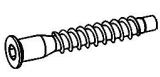
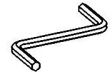

F1  7x50mm X6	F3  Hex 4mm X6	M1  12x15mm X6
---	---	---

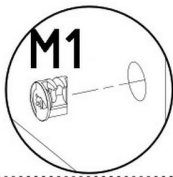
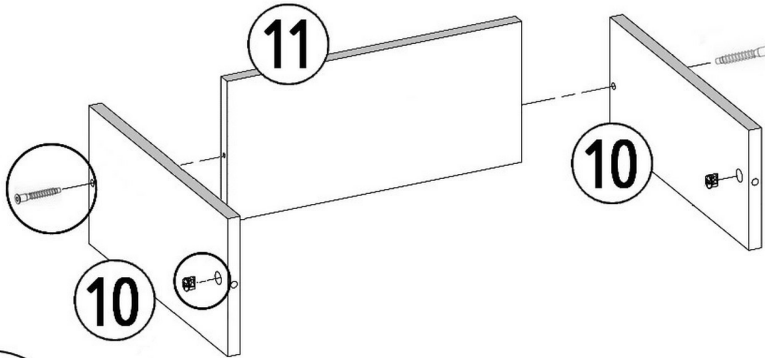
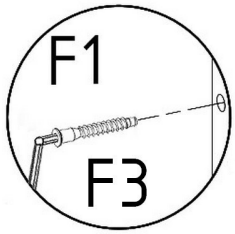
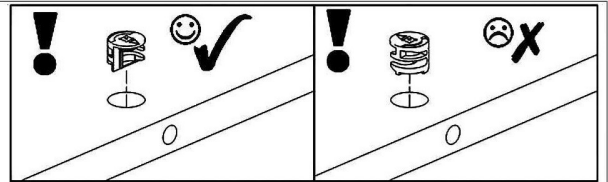

x3

N1  L=35mm X6

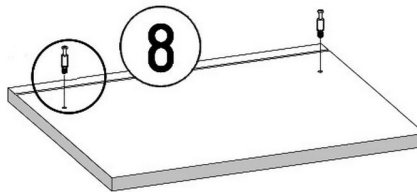
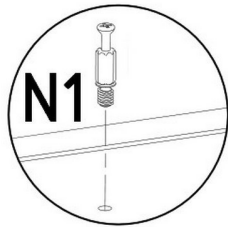
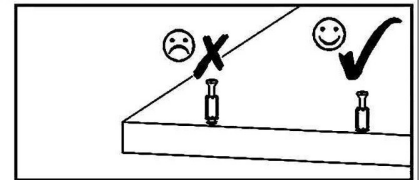

x3

B1  ø17/4mm X6

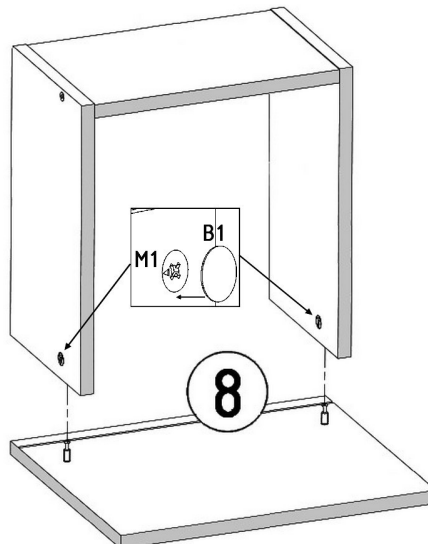
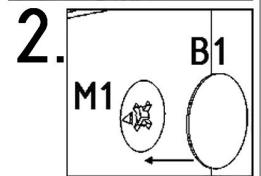
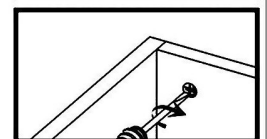
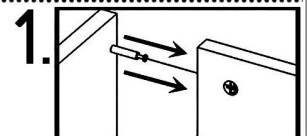

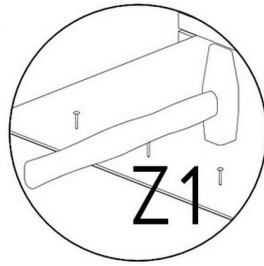
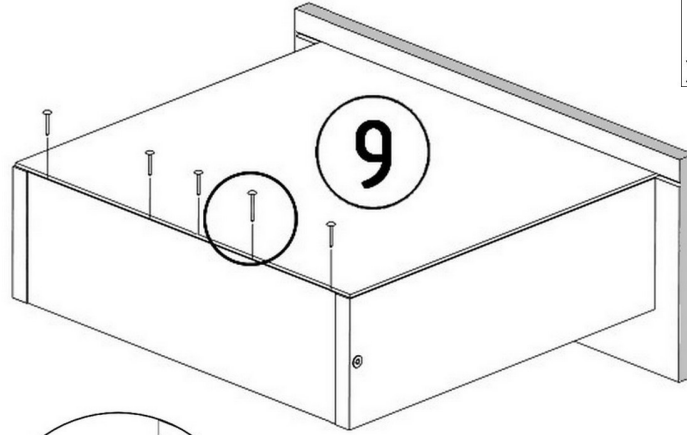
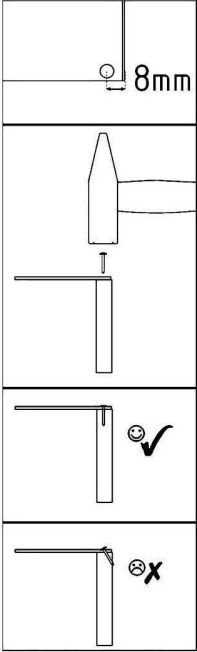
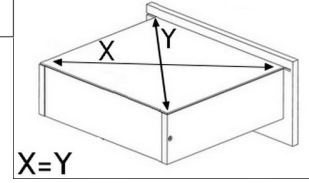
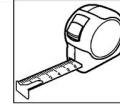
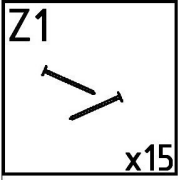

x3



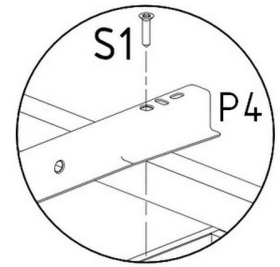
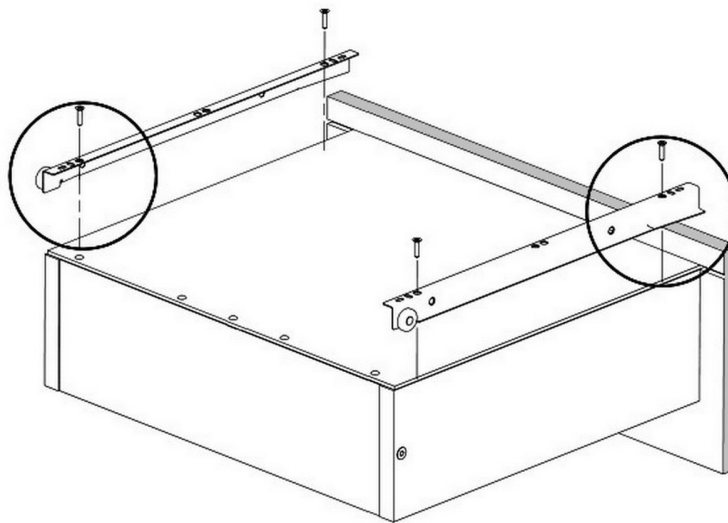
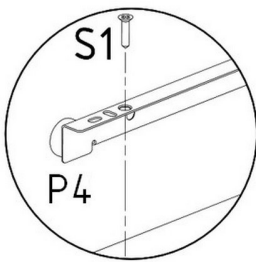
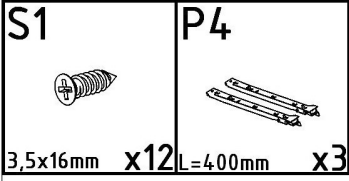

x3

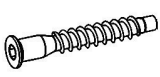
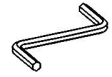

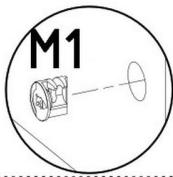
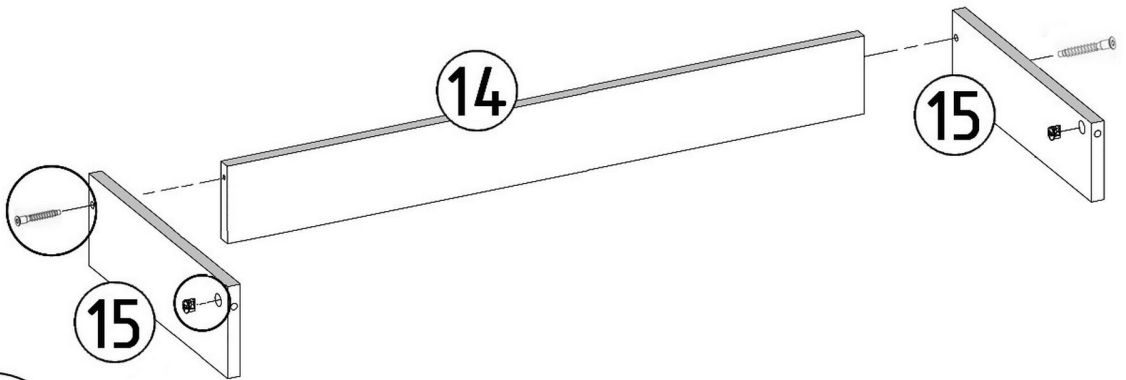
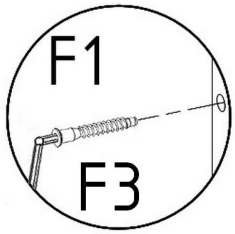
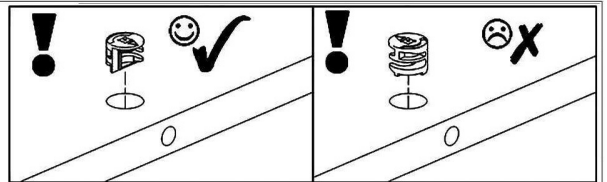

x3

F1  7x50mm x2	F3  Hex 4mm	M1  12x15mm x2
---	--	---



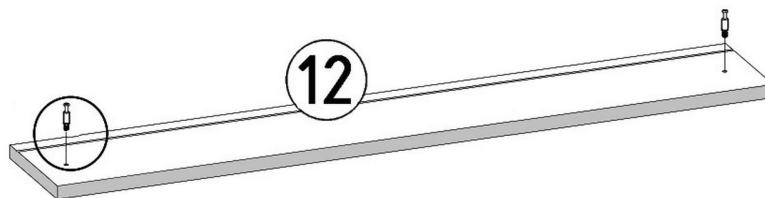
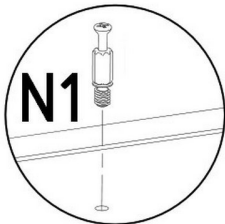
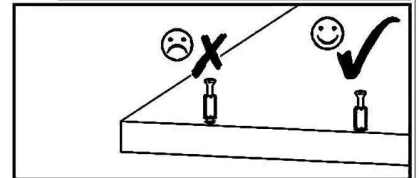



N1  L=35mm x2

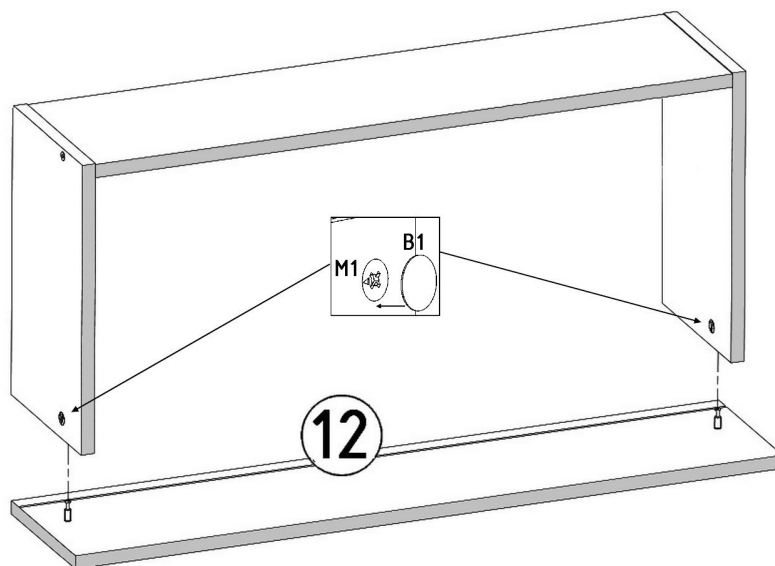
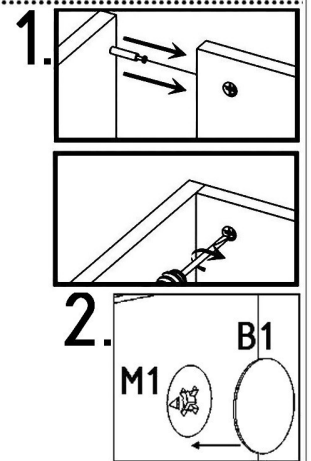

B1  ø17/4mm x2

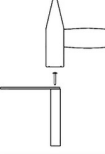
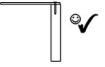

Z1

x10

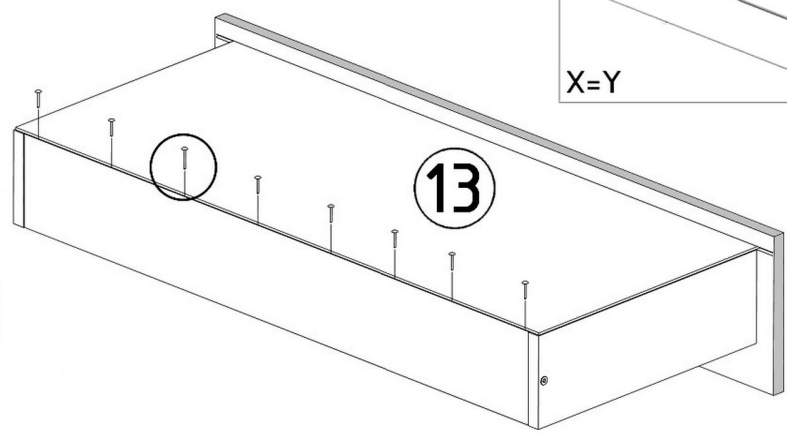
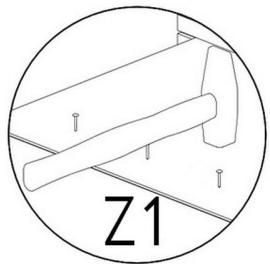
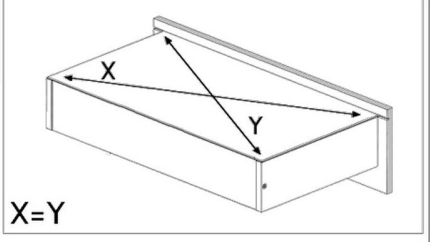
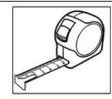
 8mm



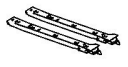

S1

3,5x16mm

P2

L=300mm

