

SD-90

PRODUCTION DATE

PACKING CODE

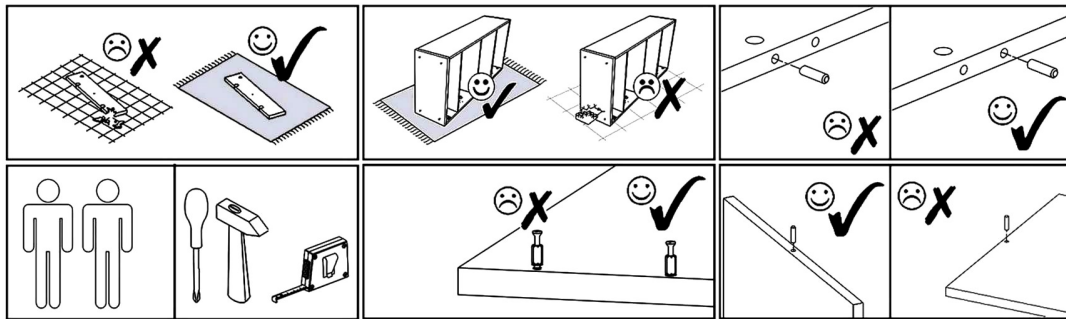
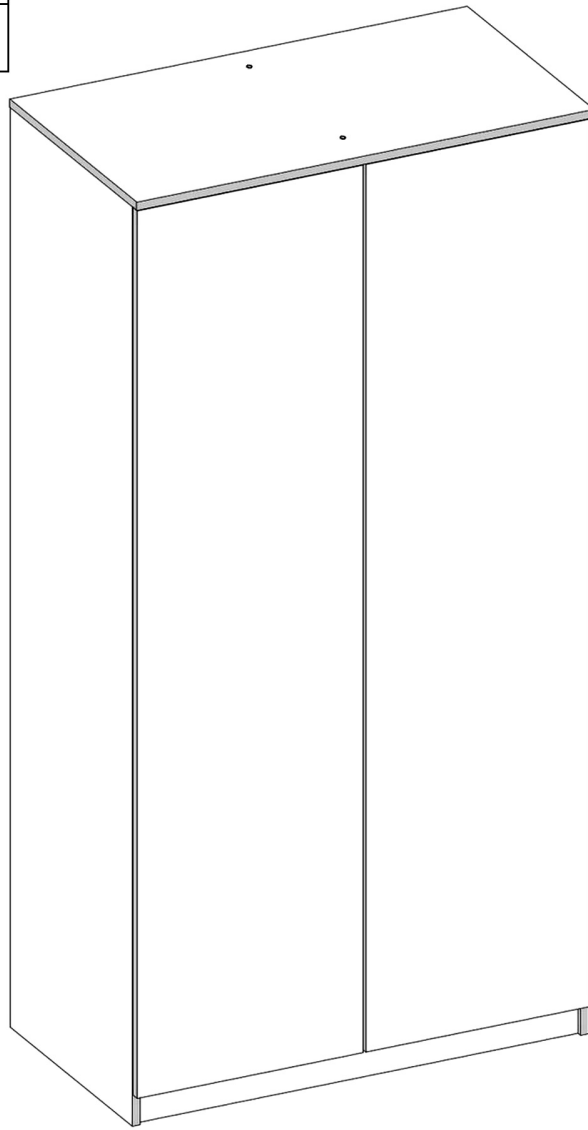

F3 Hex 4mm x1	V13 x1	V16 5x16mm x12				
N1 L=35mm x16	M1 12x15mm x16	F1 7x50mm x4	S1 3,5x16mm x12	R1 6x8mm x4	V19 x2	V15 x5
T1 x6	Z1 x80	A1 ZP x6	E1 8x30mm x20	V7 x2	V8 L=414mm x1	S6 2,5x20mm x5

SD-90

PRODUCTION DATE



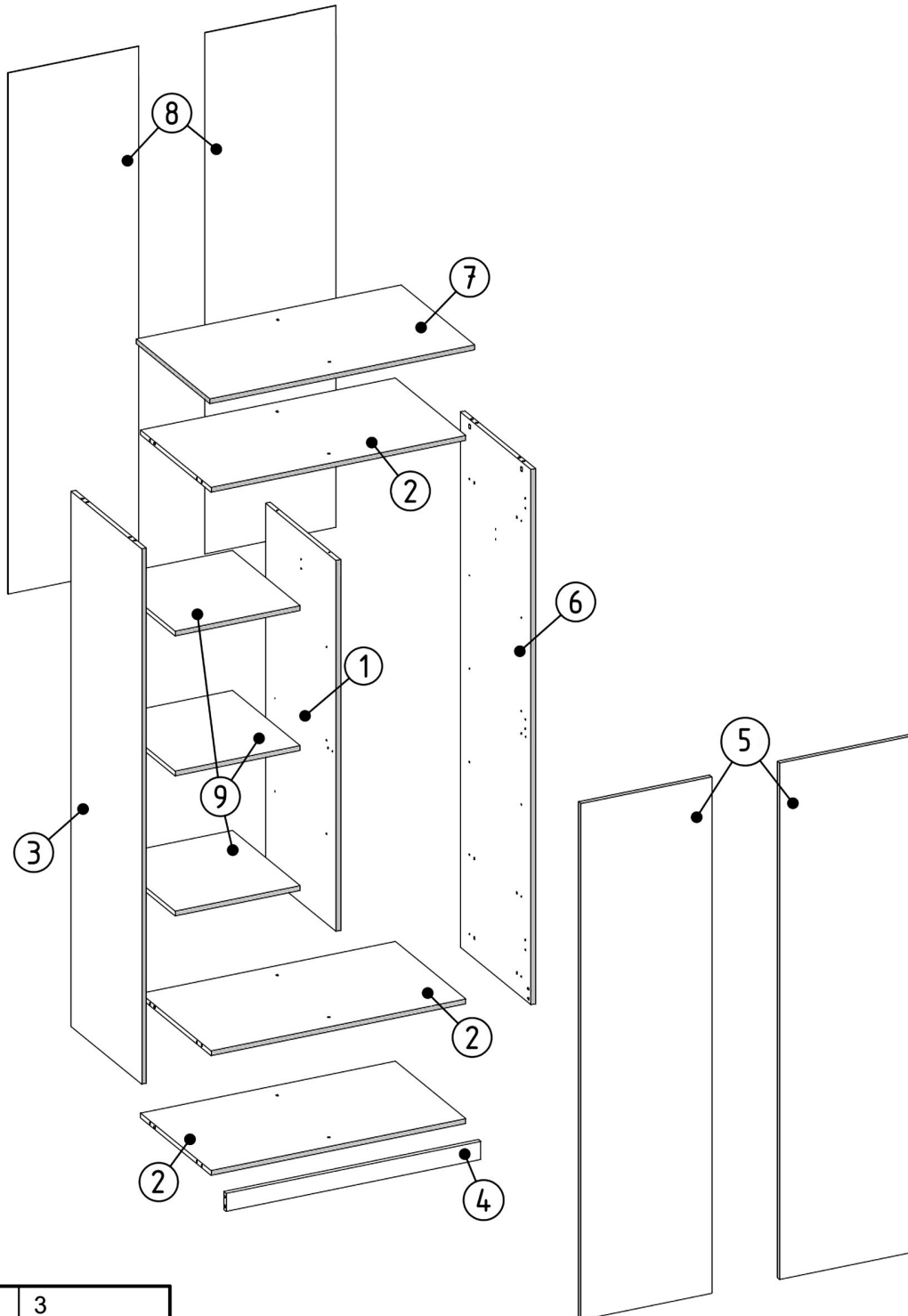

PACKING CODE

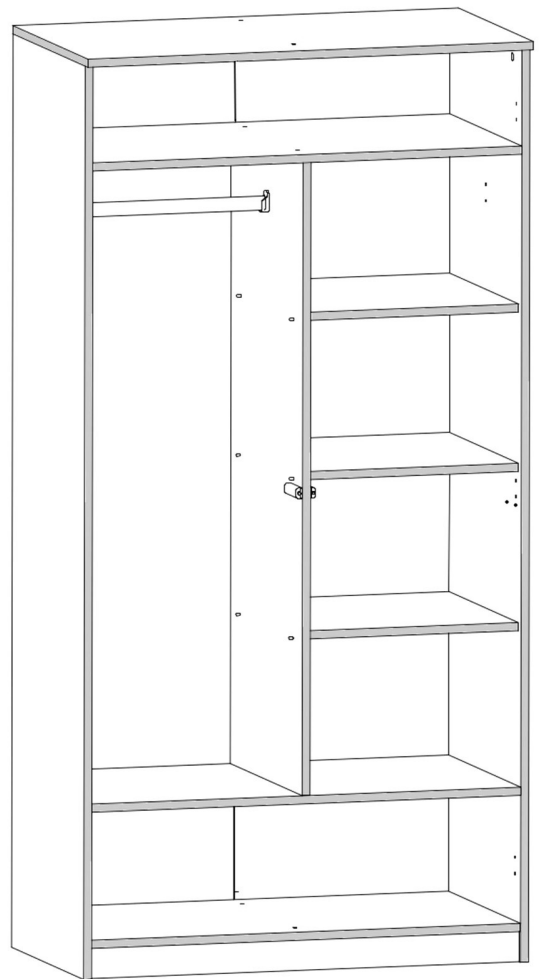
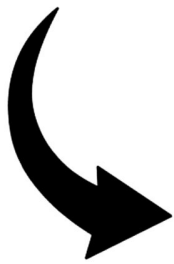
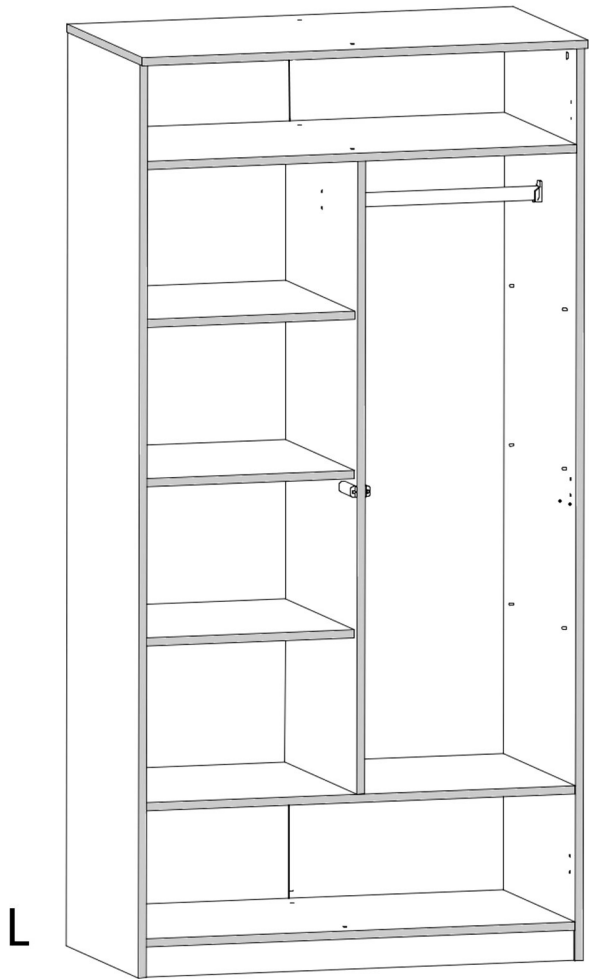

000089	9	3
002193	8	2
000604	7	1
002190	6	1
000596	5	2
000599	4	1
002191	3	1
000600	2	3
002194	1	1
ID	NUMBER	QUANTITY

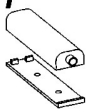

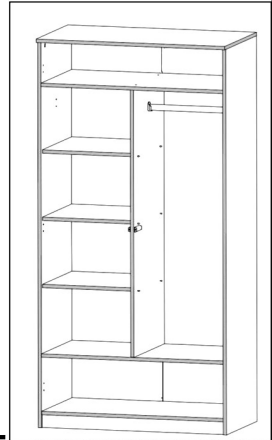
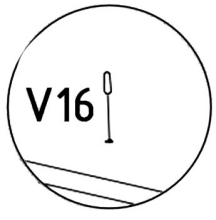
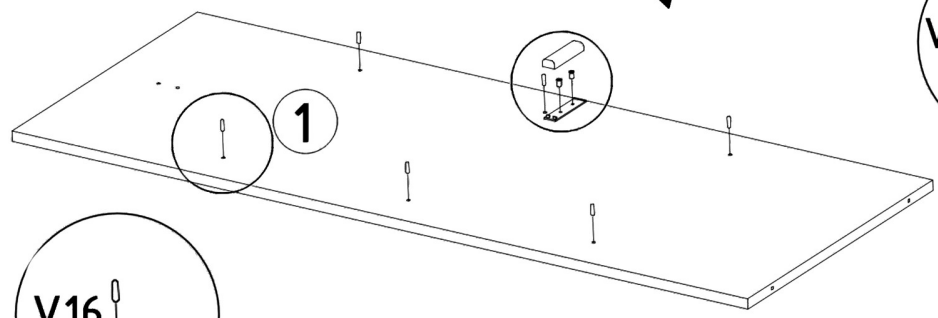
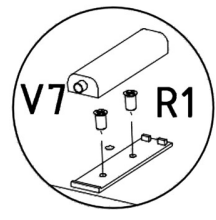
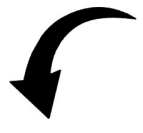
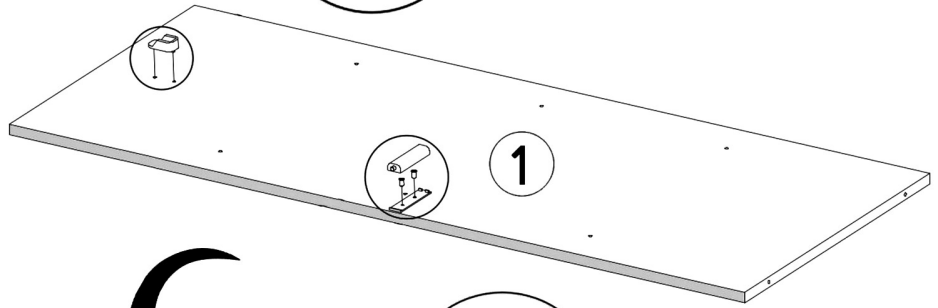
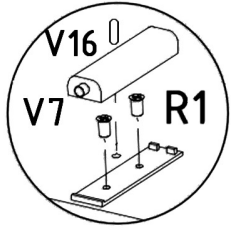
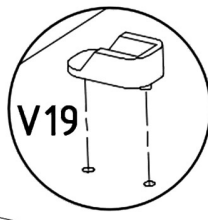

R

V7  x2 6x8mm	R1  x4	V19  x1	V16  x6 5x16mm
--	---	--	--



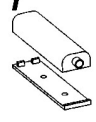

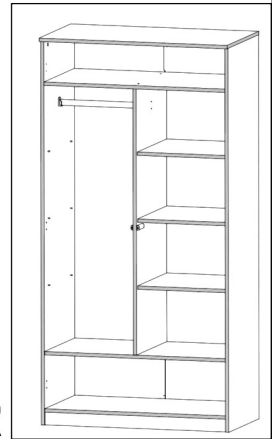
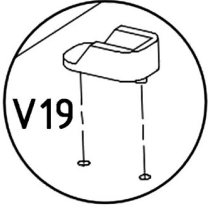
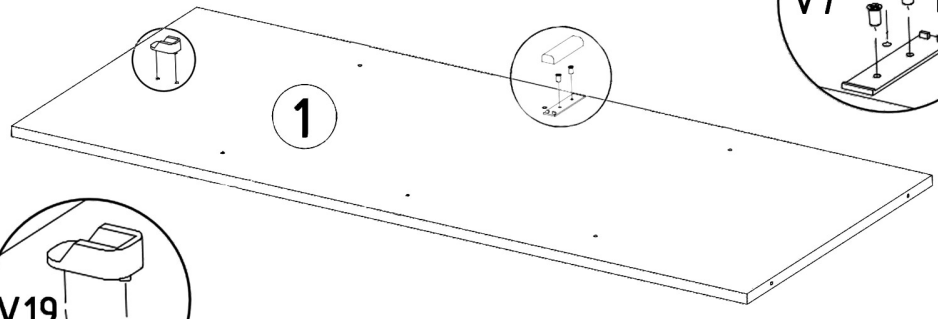
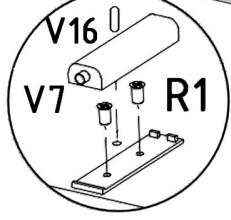
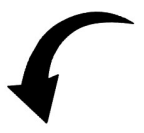
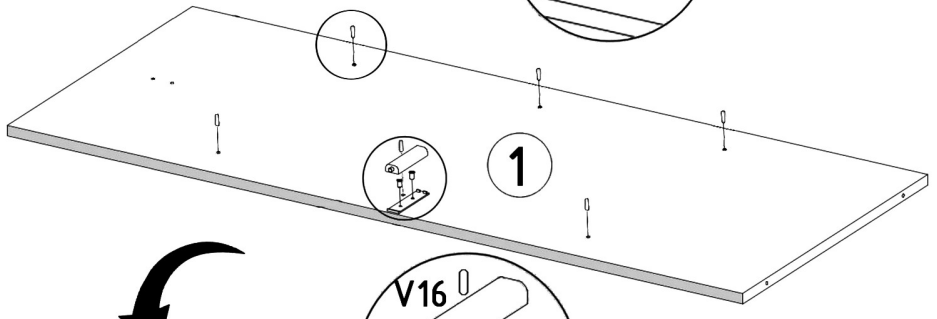
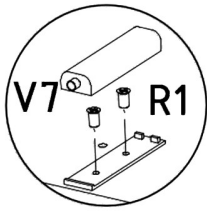

L

V16  x6 5x16mm	V7  x2 6x8mm	R1  x4	V19  x1
---	--	--	---





R

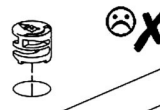

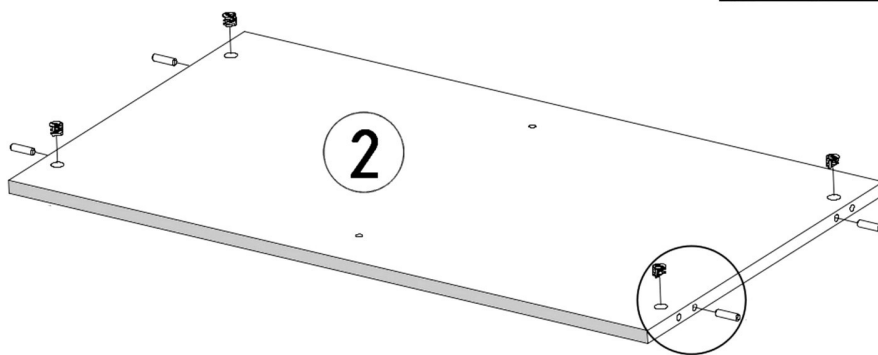
M1  12x15mm x12	E1  8x30mm x12
--	---

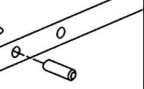
   
--

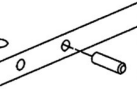



 	 
---	---

x3

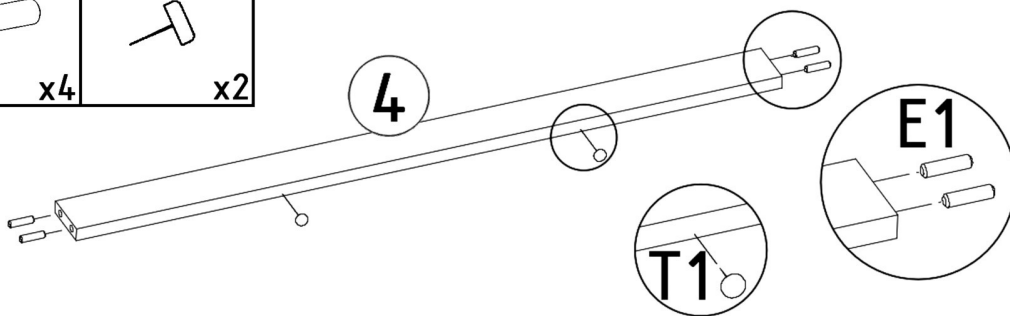

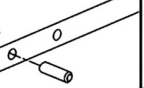

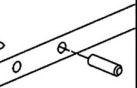
E1  8x30mm x4	T1  x2
--	--

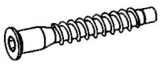
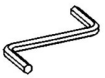

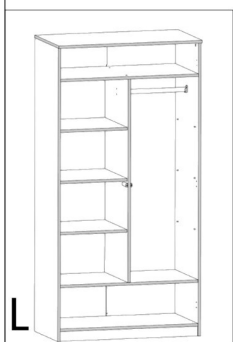
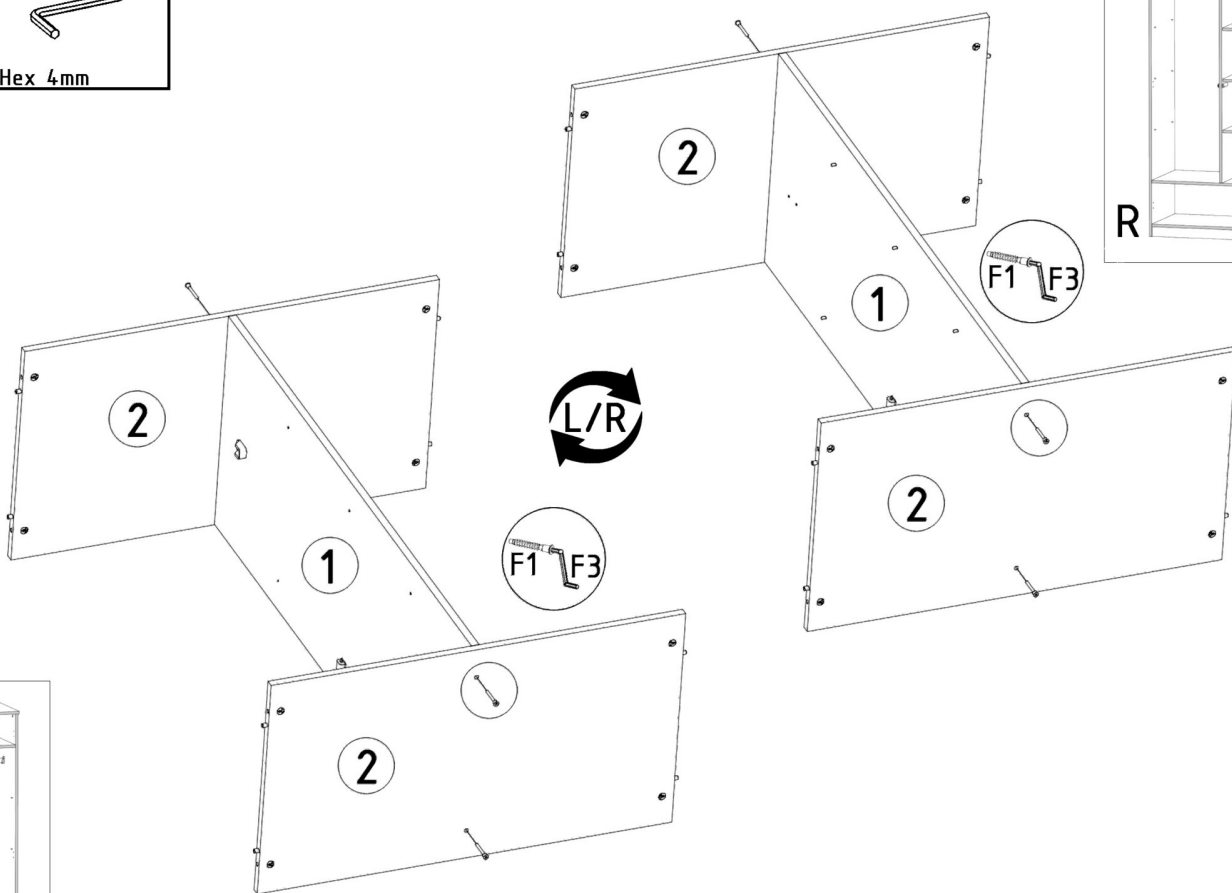

 	 
---	---

F1  7x50mm x4	F3  Hex 4mm
--	---

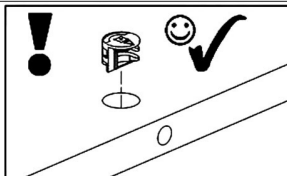
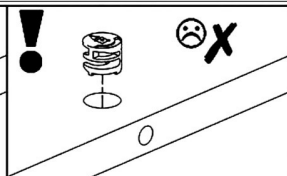

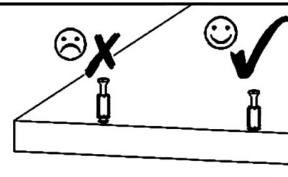
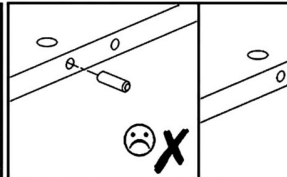

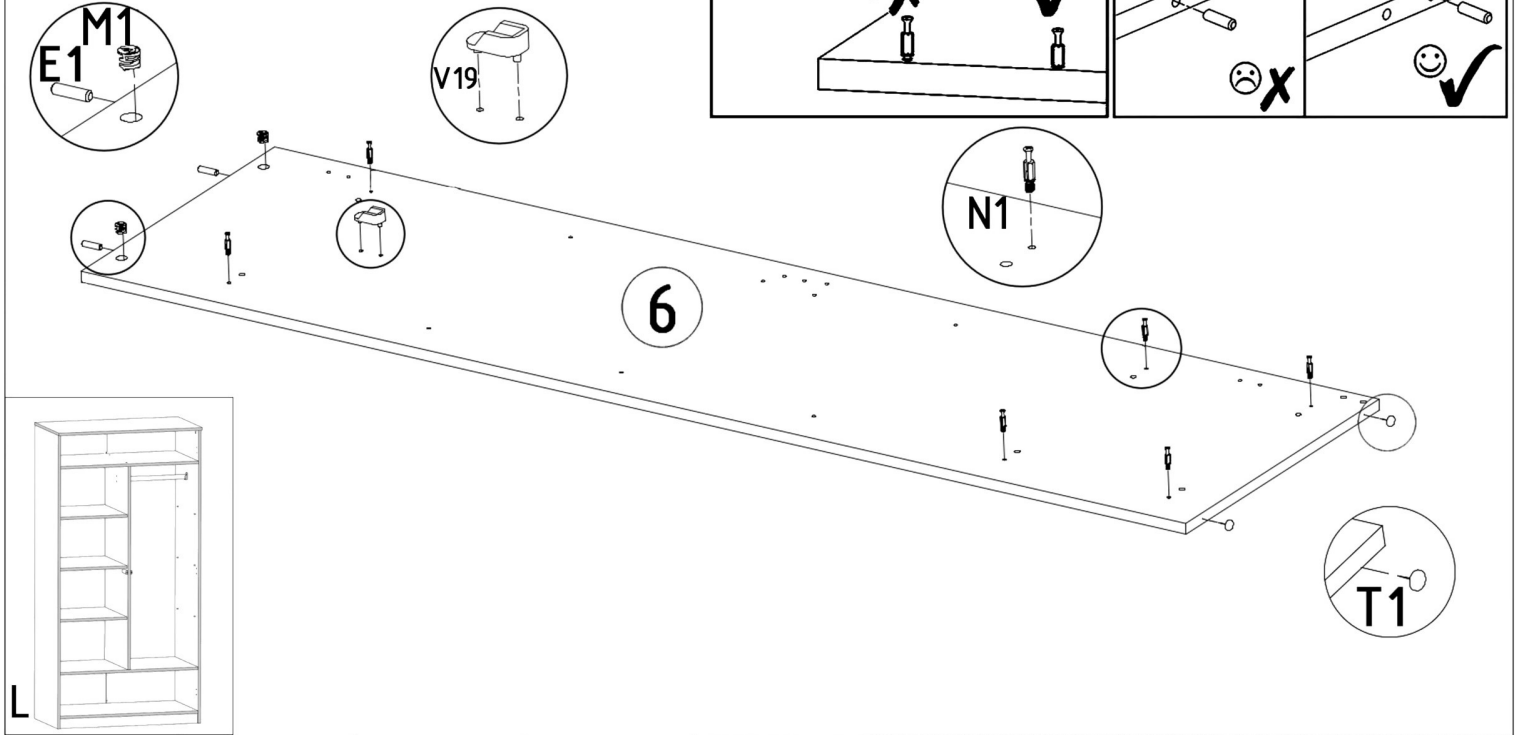

T1  x2	M1  12x15mm x2	E1  8x30mm x2	N1  L=35mm x2	V19  x1		
---	---	---	---	--	---	--



		
--	---	---

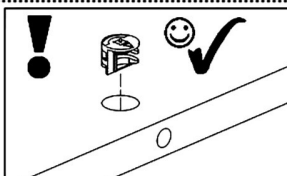
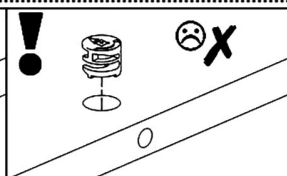

6

L

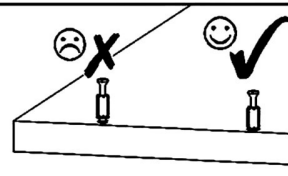
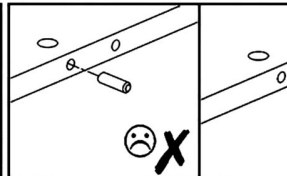

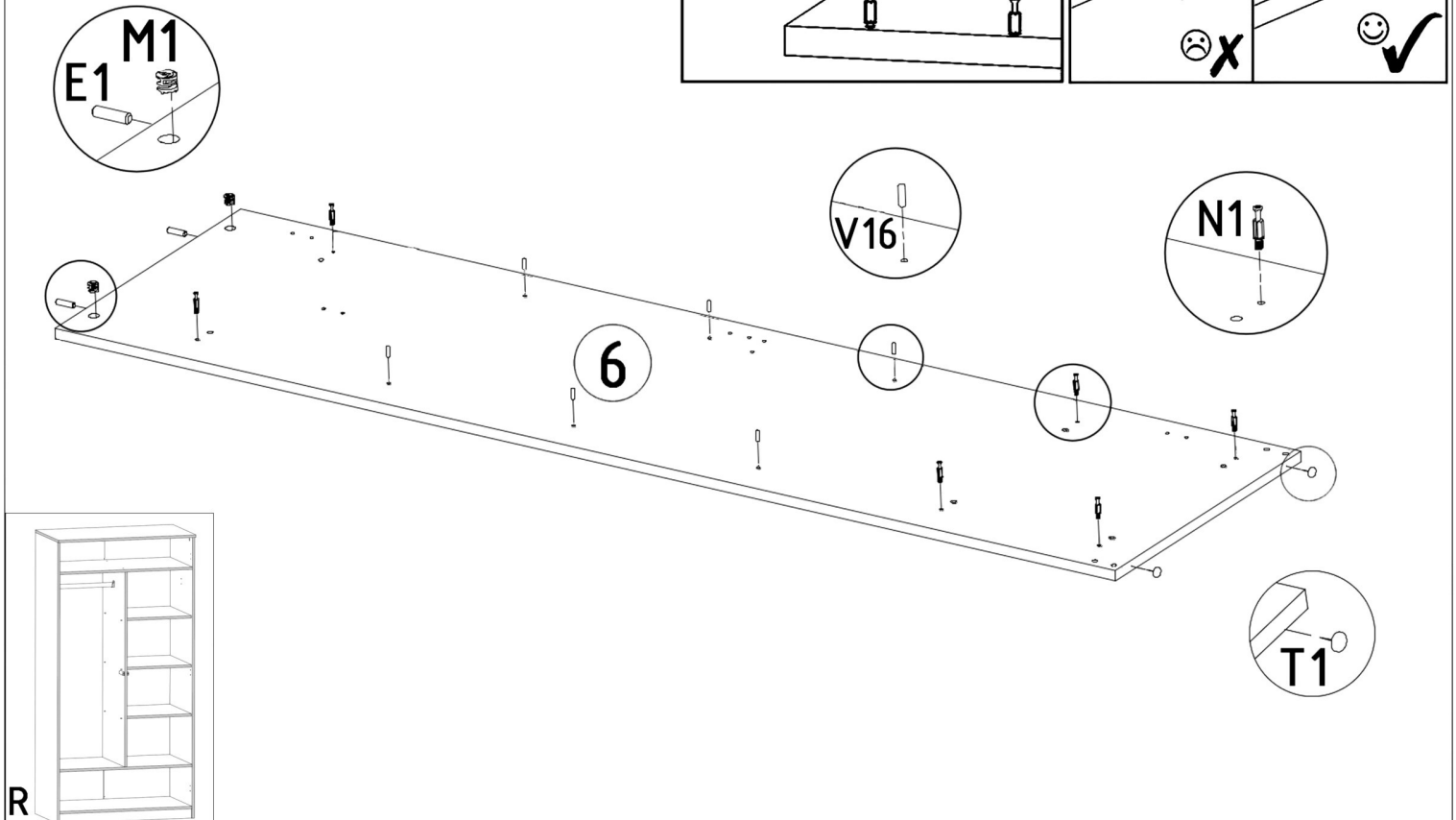

T1  x2	M1  12x15mm x2	E1  8x30mm x2	N1  L=35mm x2	V16  5x16mm x6		
---	--	---	---	--	--	---

		
--	---	---





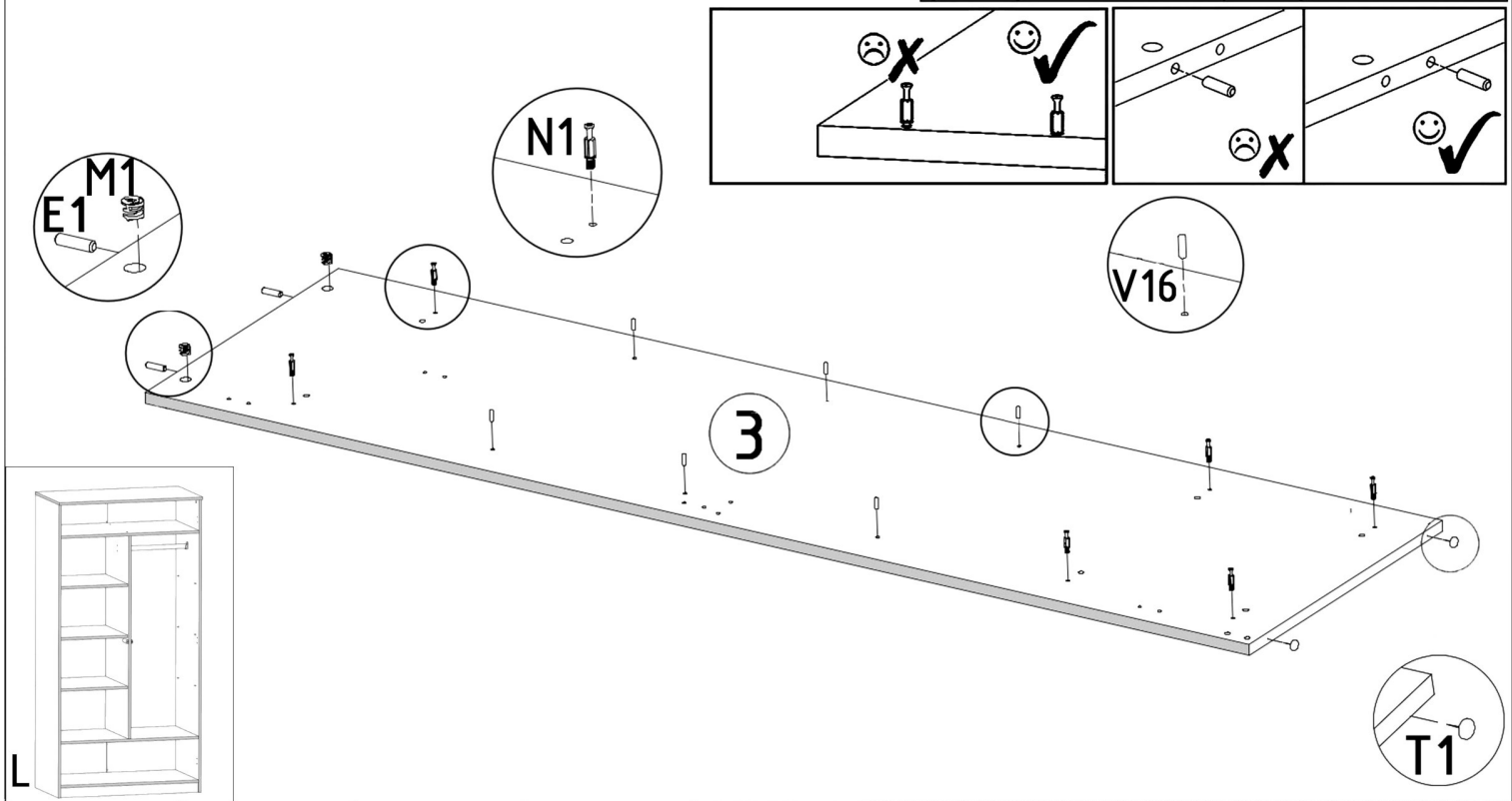
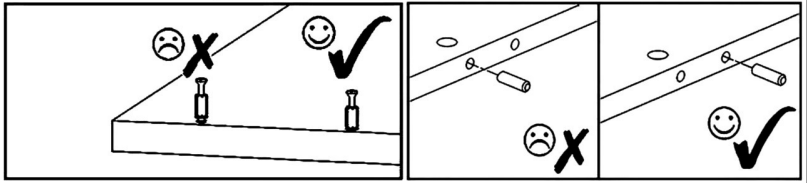
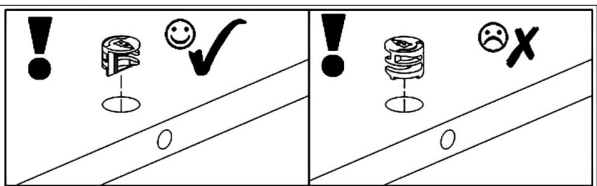

6

R

T1 	M1 	E1 	N1 	V16 			
x2	12x15mm	x2	8x30mm	x2 L=35mm	x6	5x16mm	x6



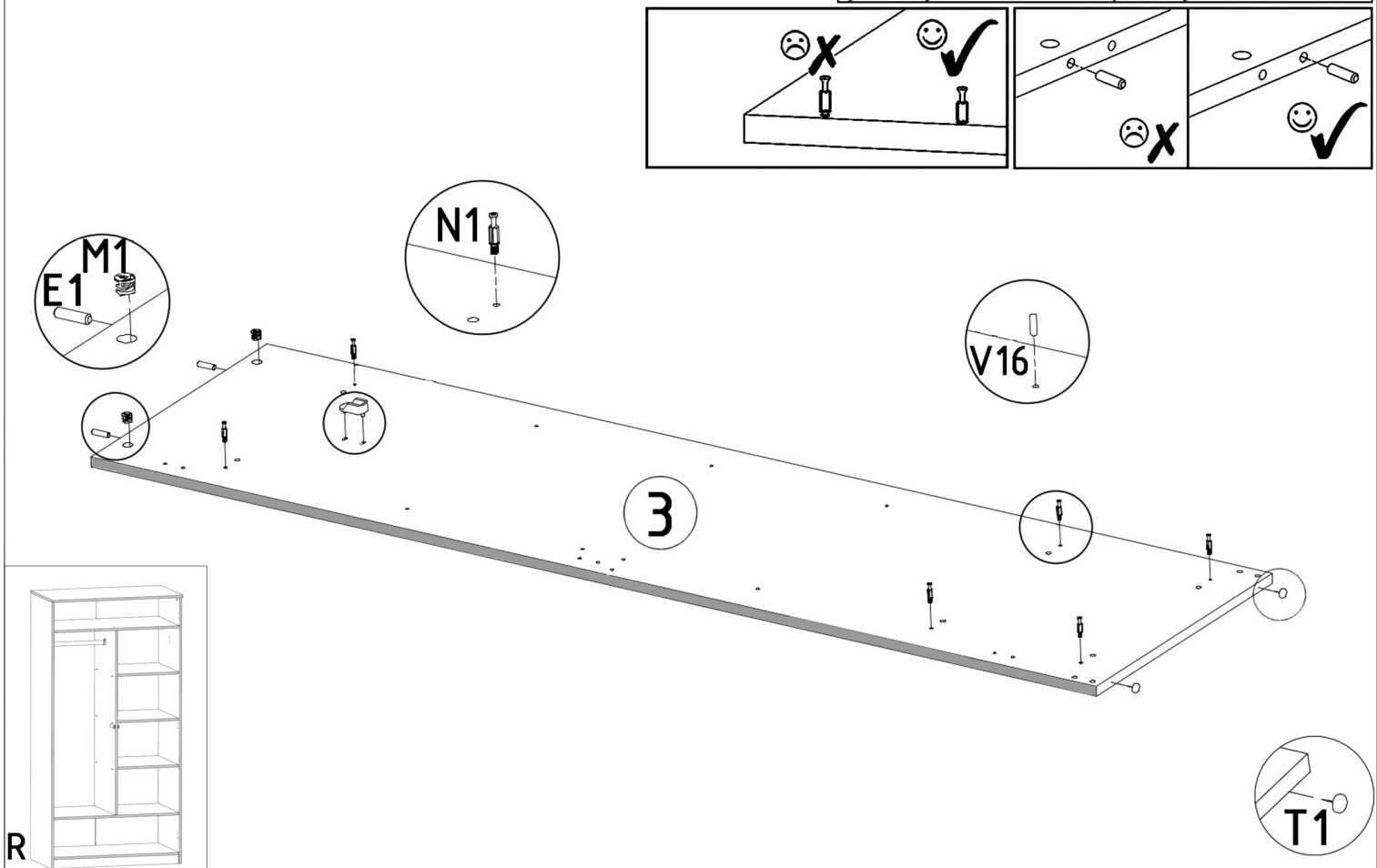
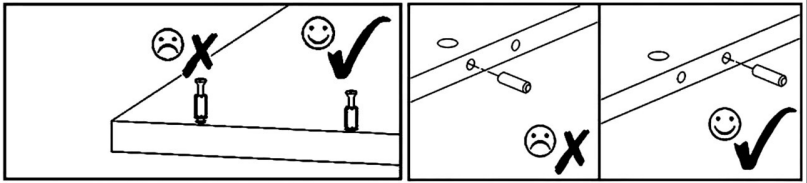
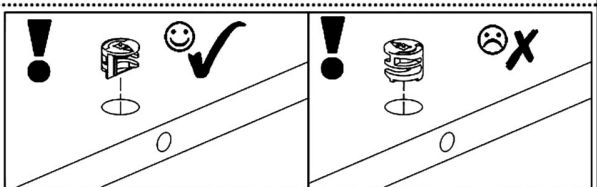

T1 	M1 	E1 	N1 	V19 		
x2	12x15mm	x2	8x30mm	x2 L=35mm	x6	x1

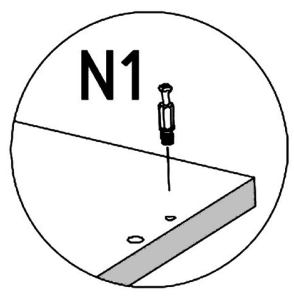
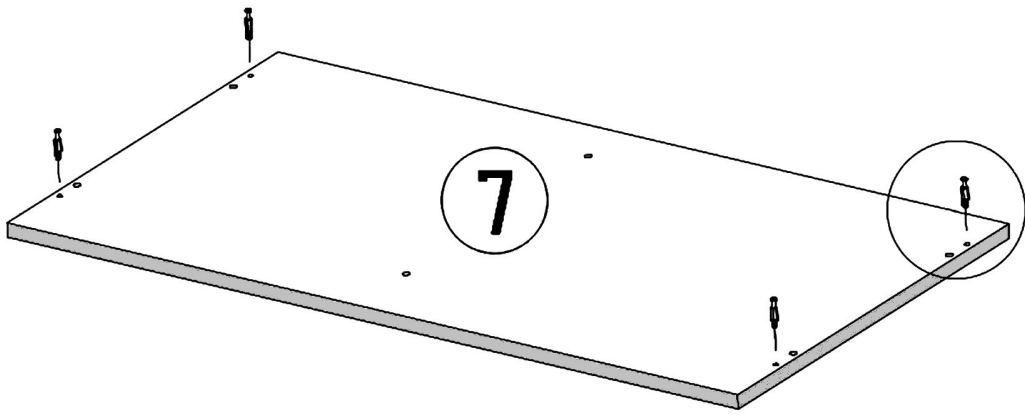
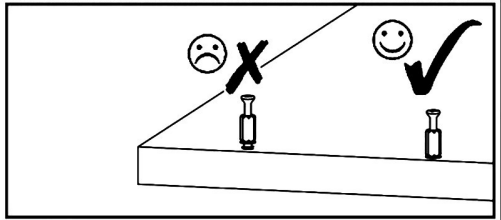
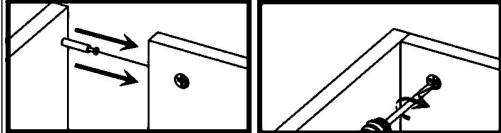
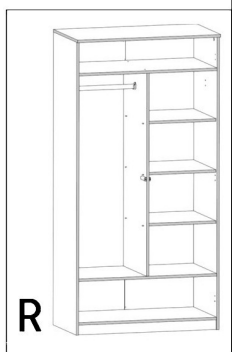
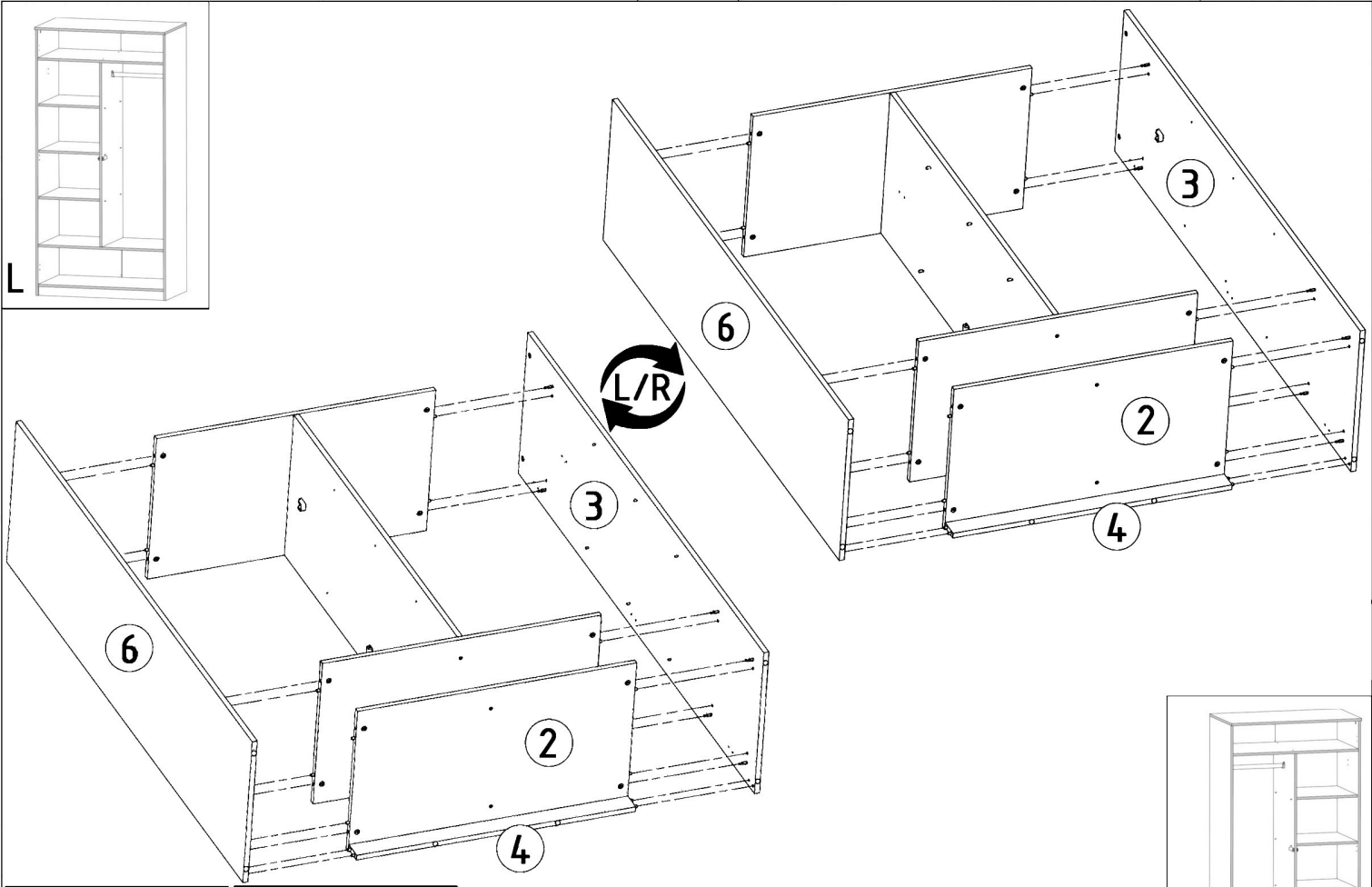

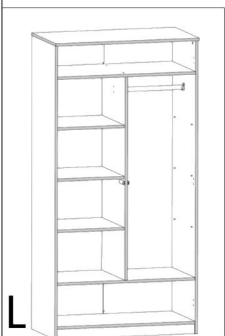
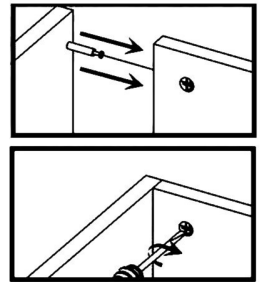
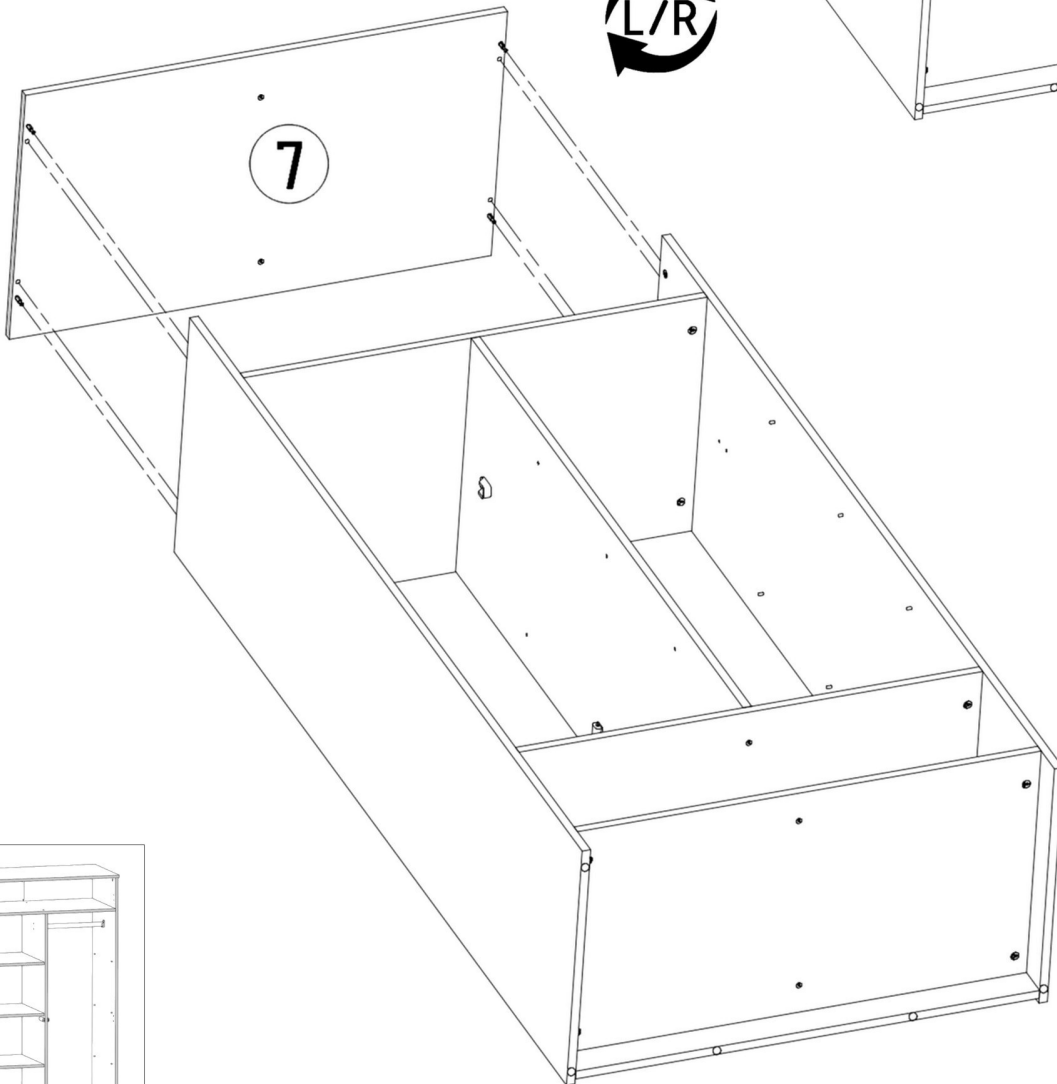
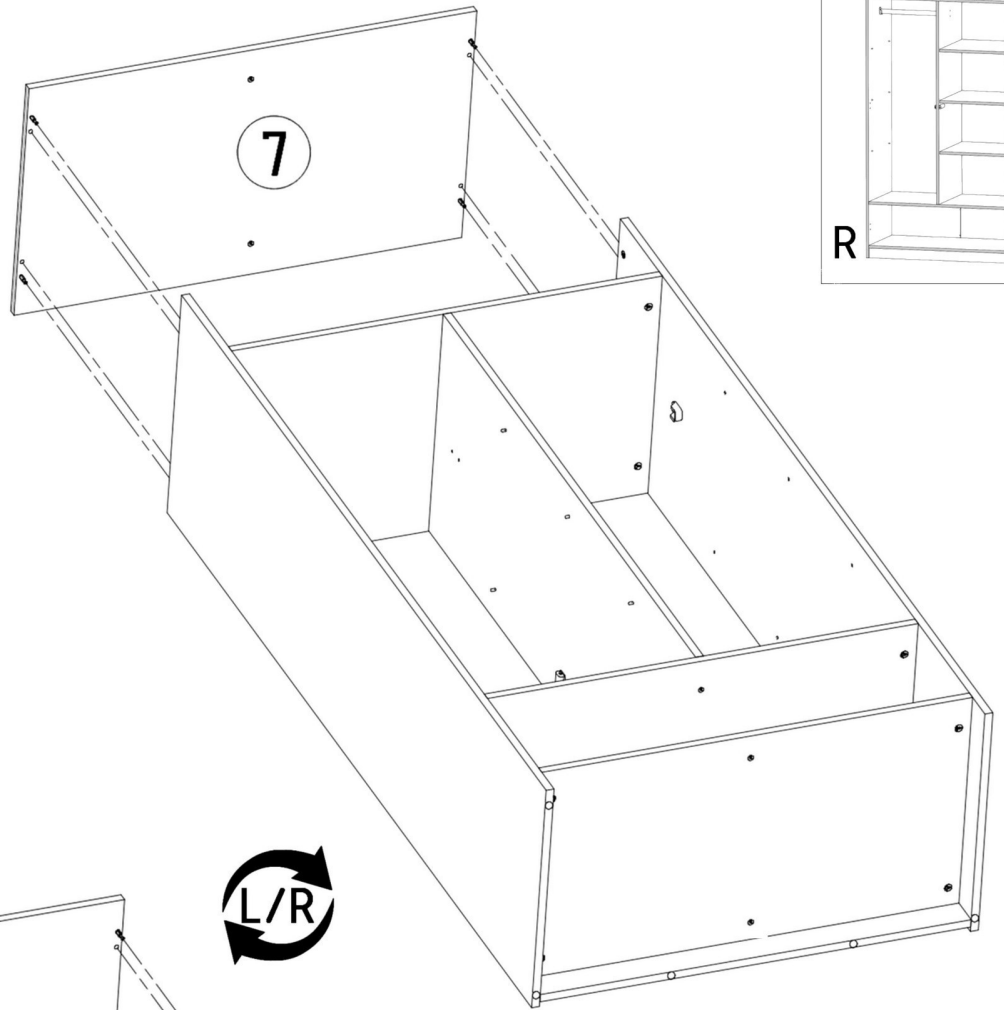



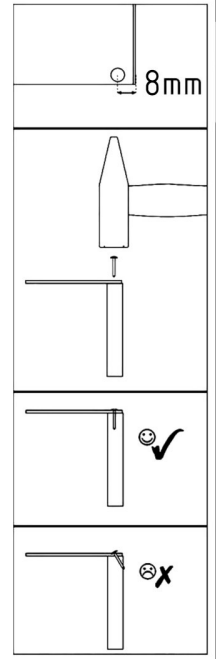
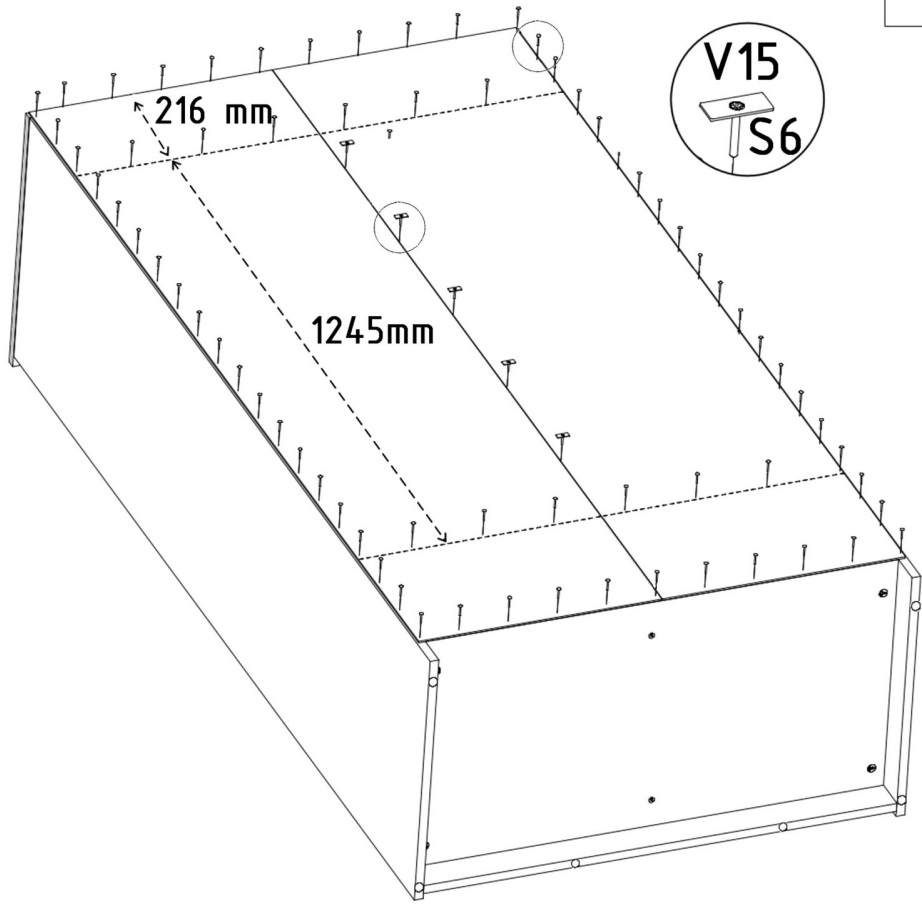
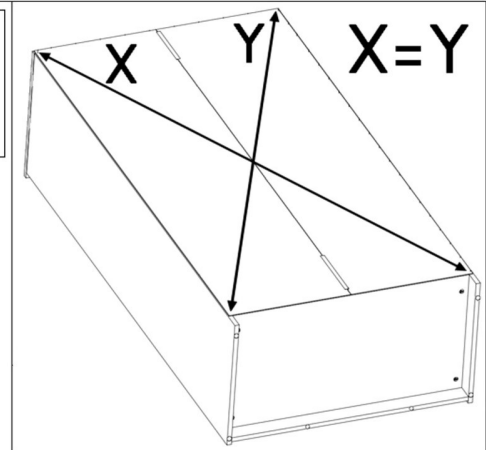
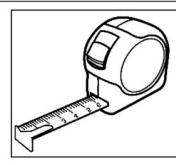

<p>S6</p>  <p>2,5x20mm x5</p>	<p>V15</p>  <p>x5</p>	<p>Z1</p>  <p>x80</p>
---	---	--



<p>S1</p>  <p>3,5x16mm x12</p>	<p>A1</p>  <p>ZP x6</p>
---	---

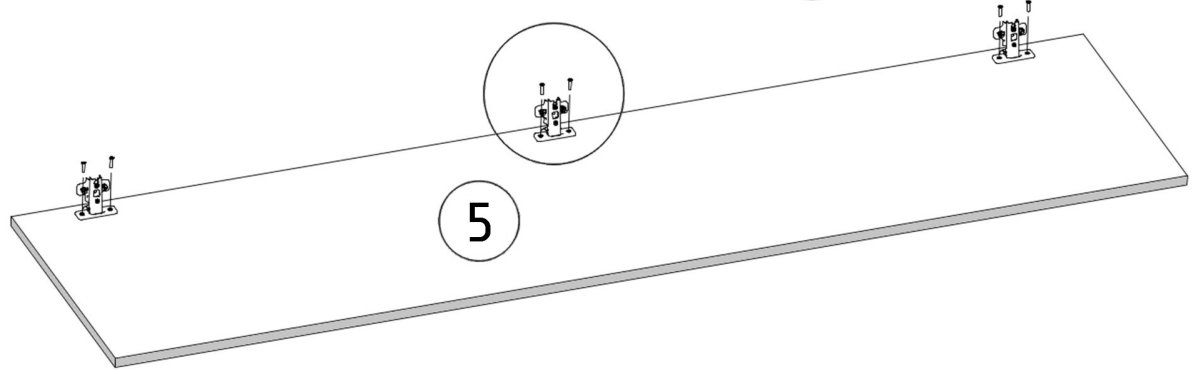
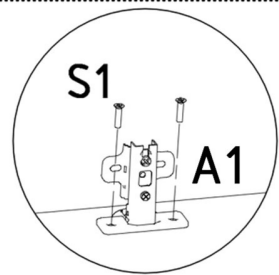

x2

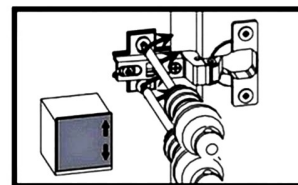
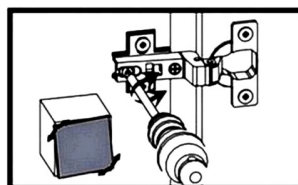
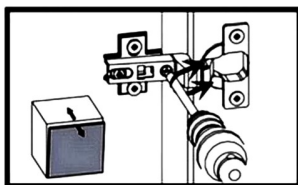
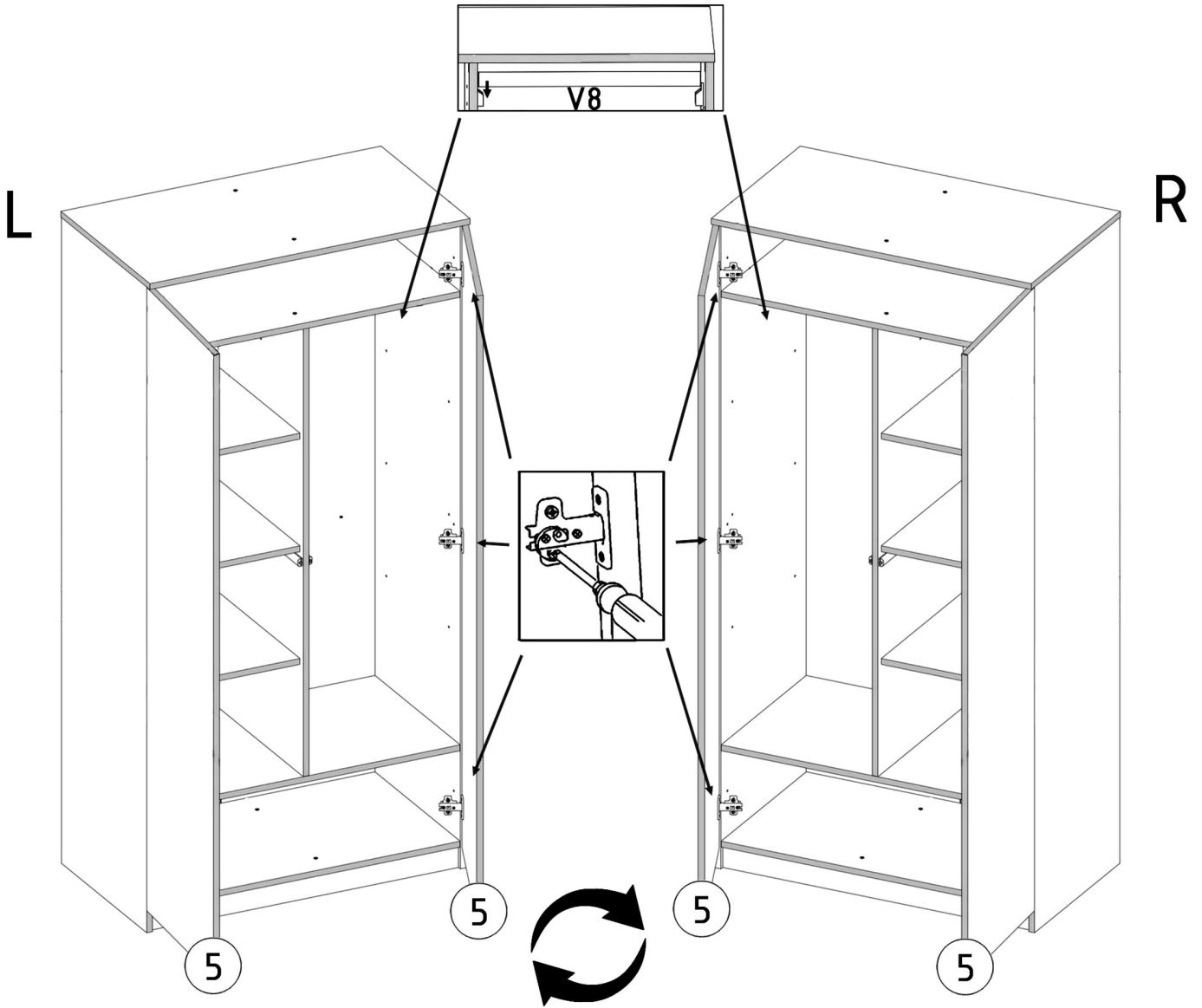
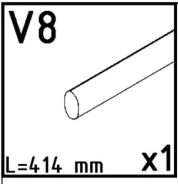

V13



x1

