

OLYMPO_2D

PRODUCTION DATE

PACKING CODE

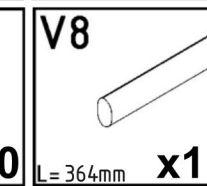

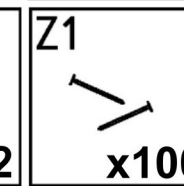
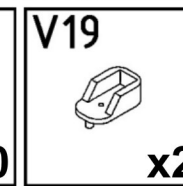
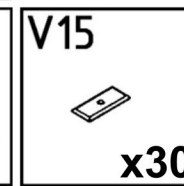
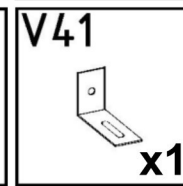
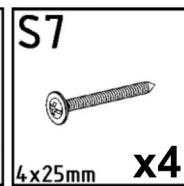
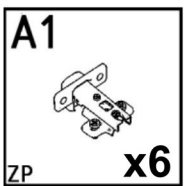
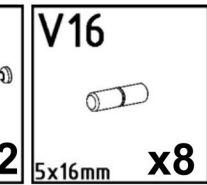
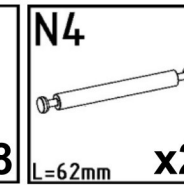
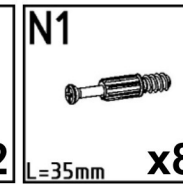
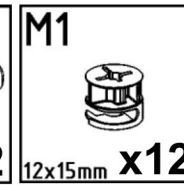
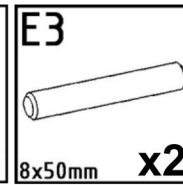
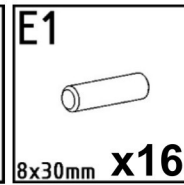
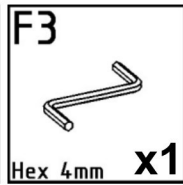
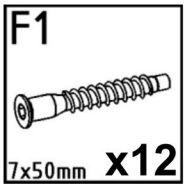
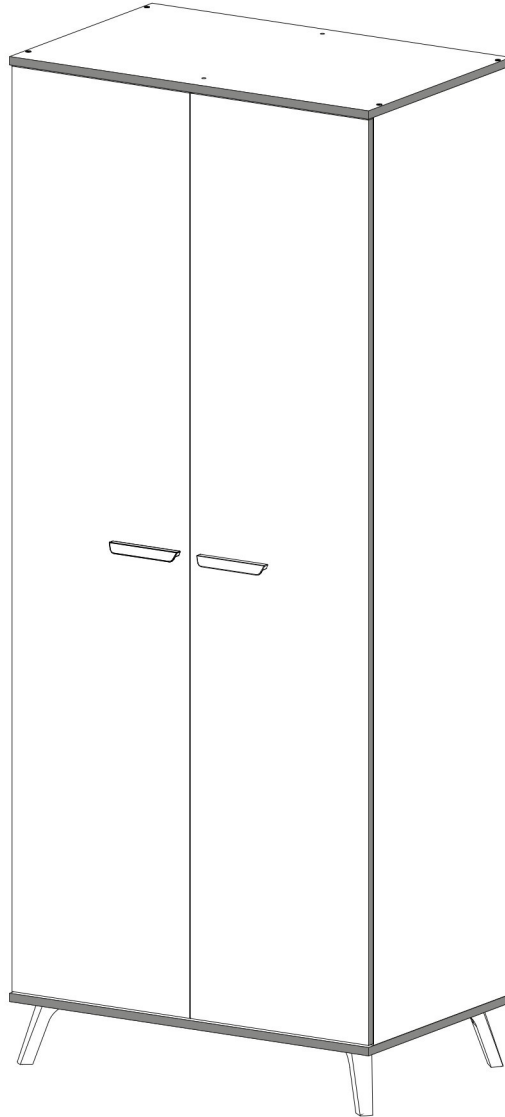
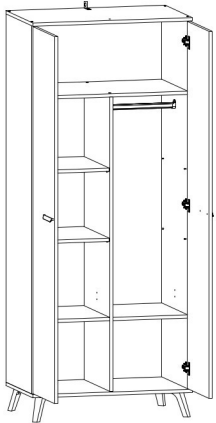
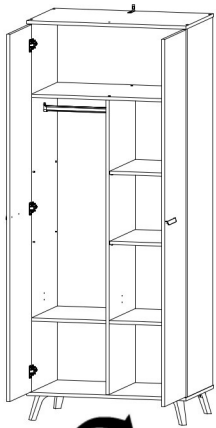
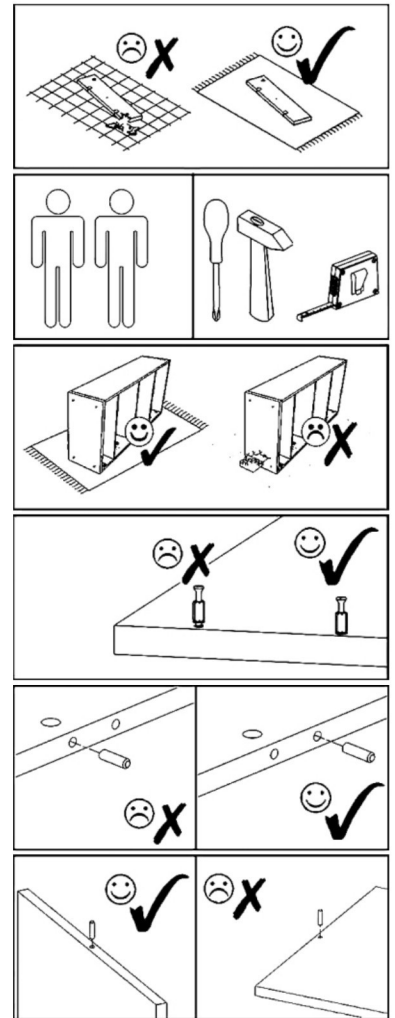

OLYMPO_2D

PRODUCTION DATE

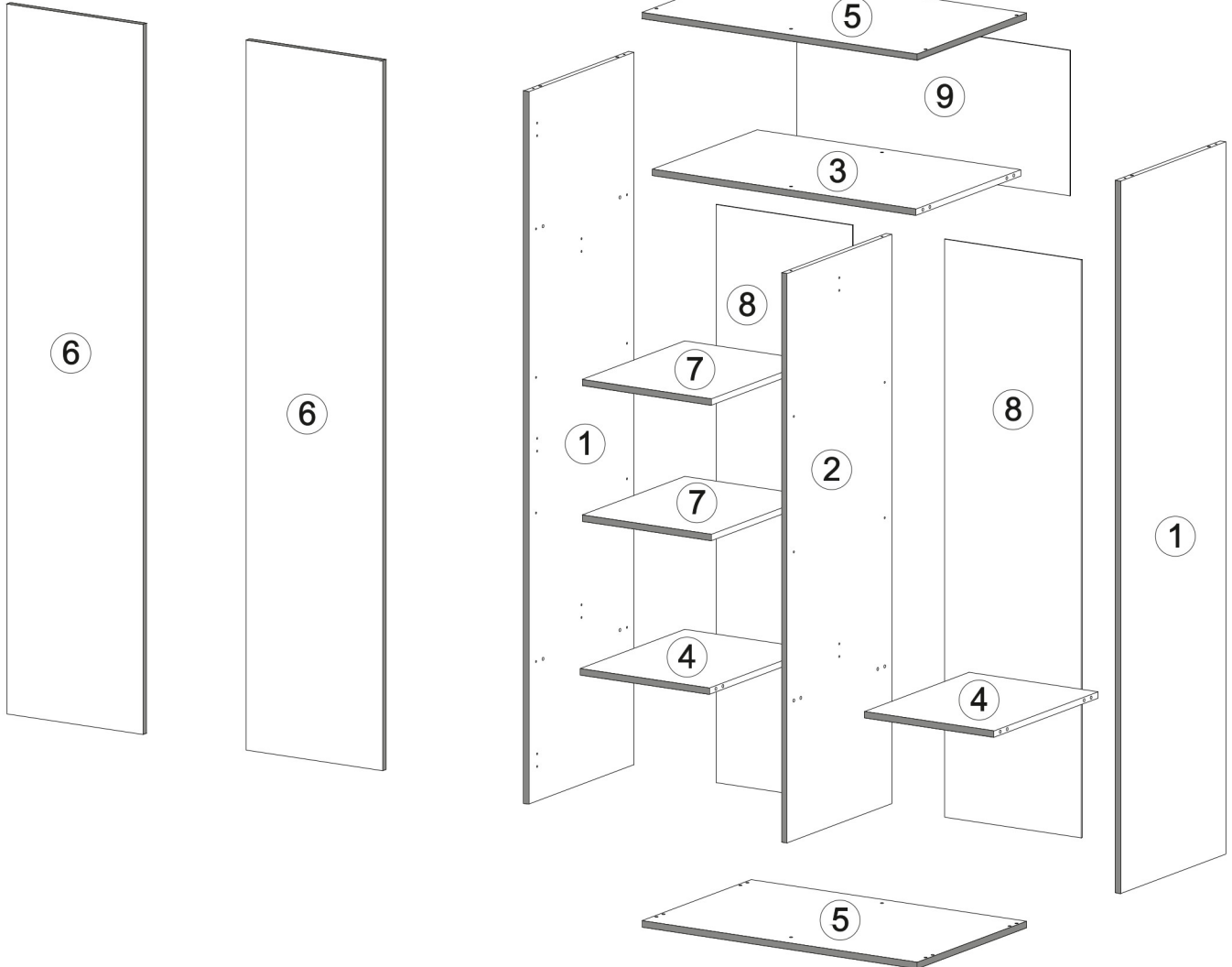

PACKING CODE





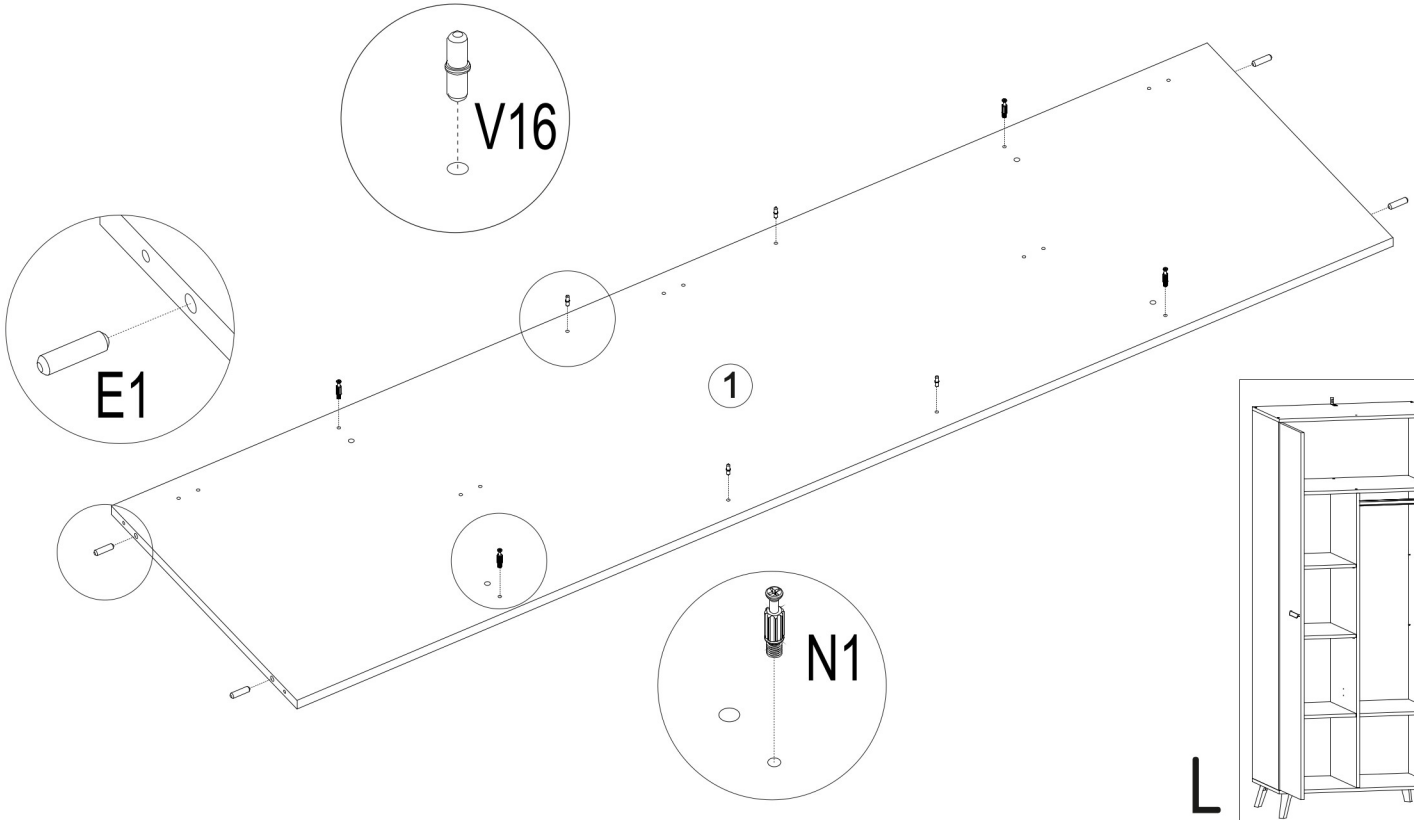
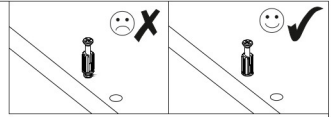

002245	1	2
002250	2	1
002251	3	1
002253	4	2
002252	5	2
002246	6	2
002249	7	2
002247	8	2
002248	9	1
ID	NUMBER	QUANTITY

E1  8x30mm x4	N1  L=35mm x4	V16  5x16mm x4
---	--	---

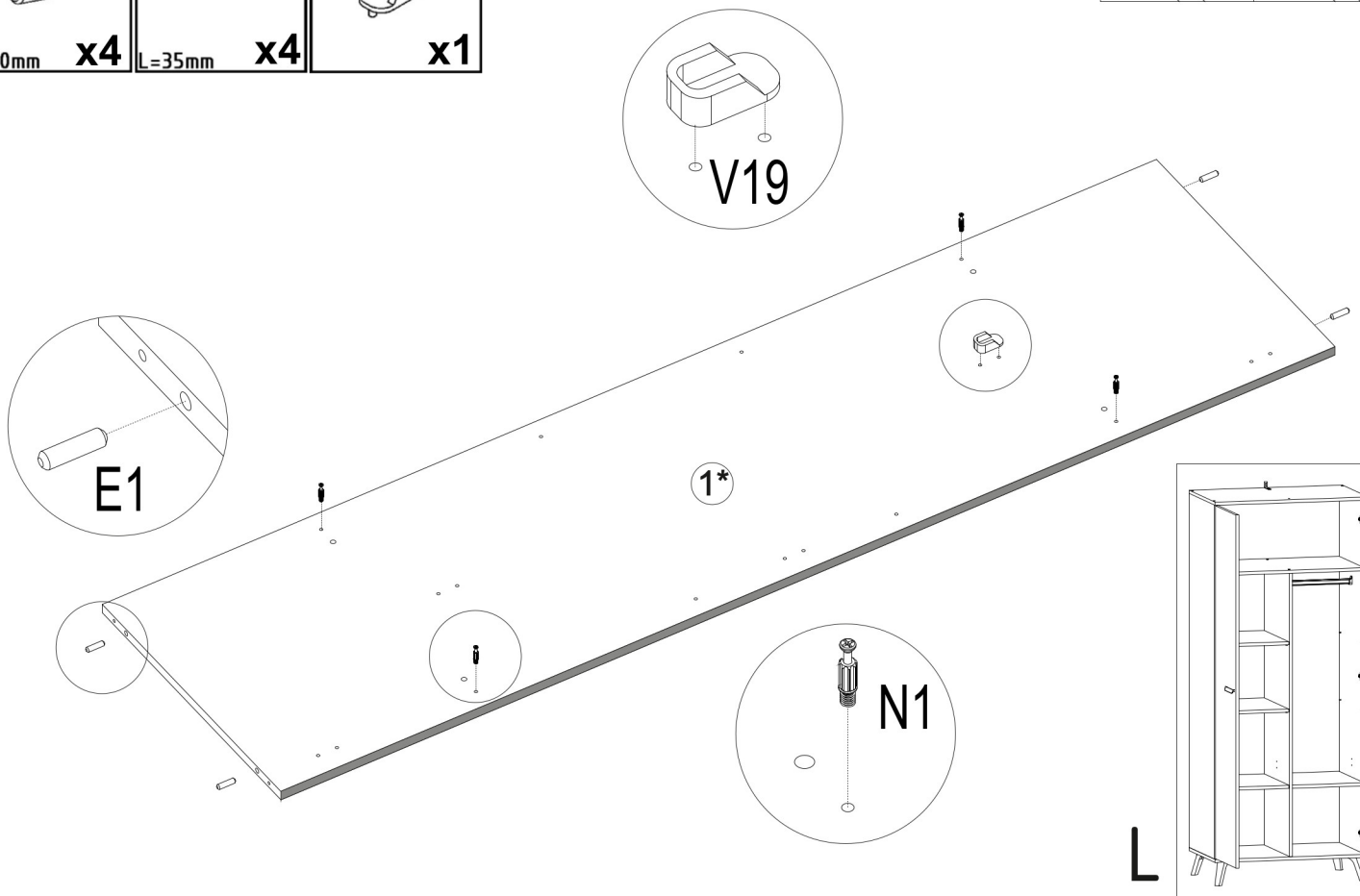
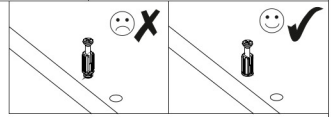



E1  8x30mm x4	N1  L=35mm x4	V19  x1
---	--	--



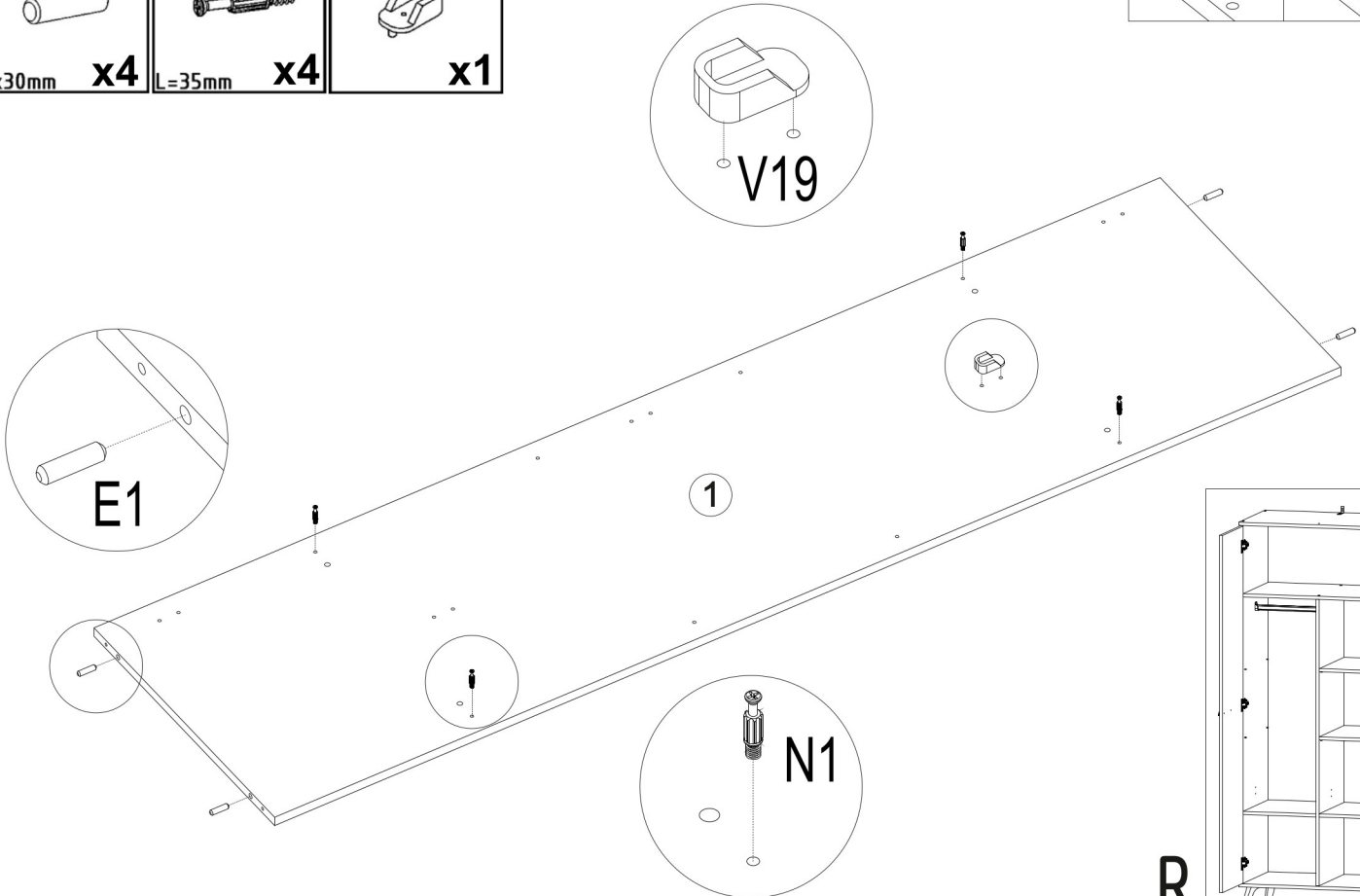
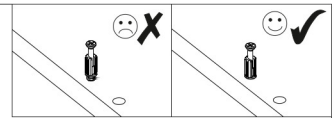

E1  8x30mm x4	N1  L=35mm x4	V19  x1
---	--	--



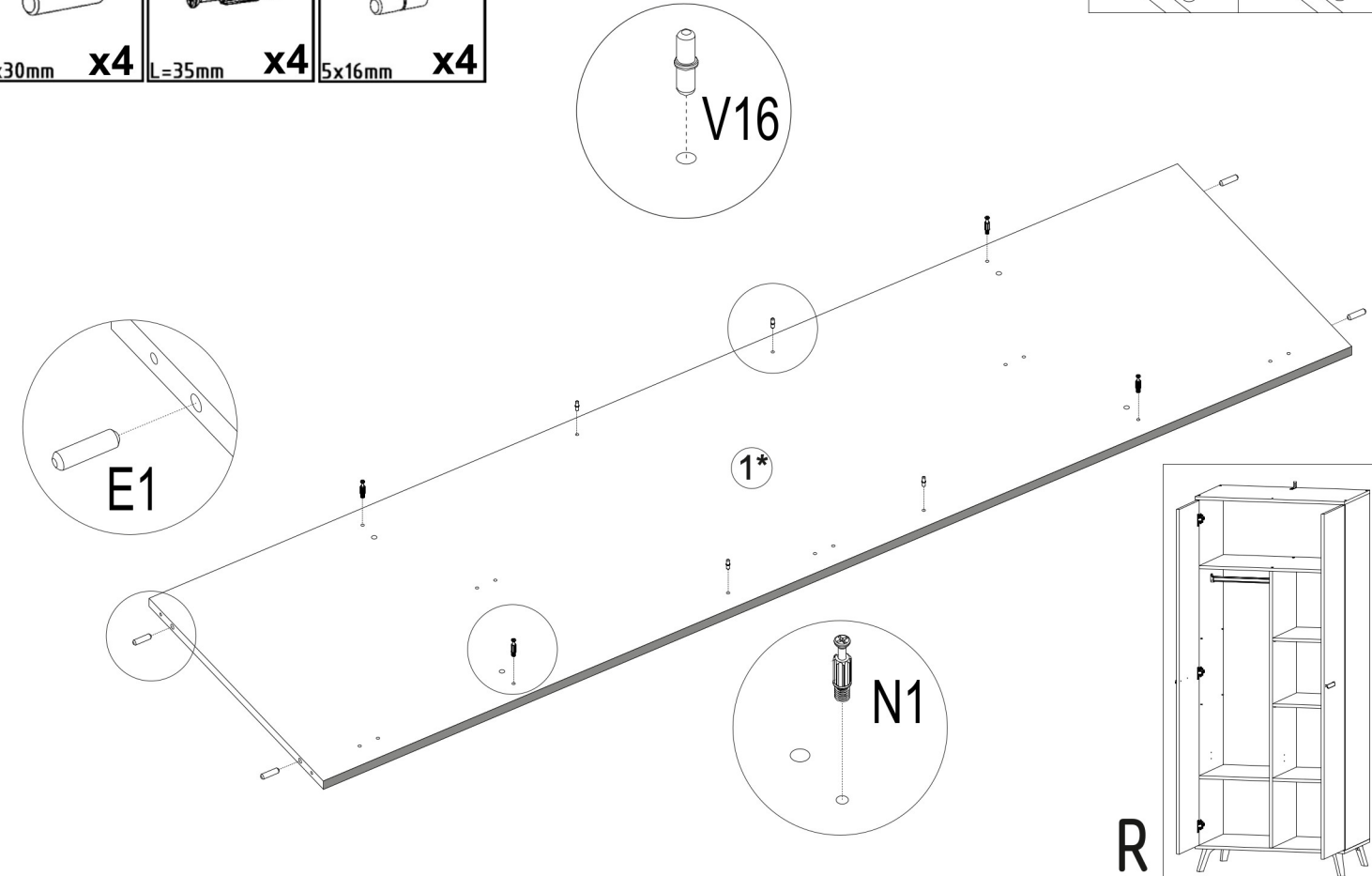
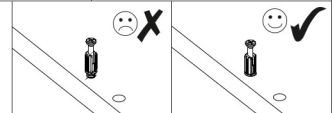

E1  8x30mm x4	N1  L=35mm x4	V16  5x16mm x4
---	--	---



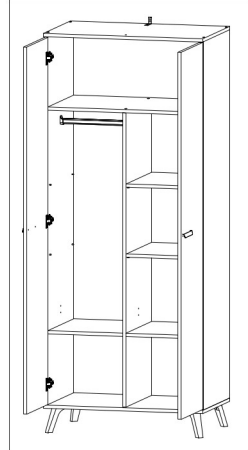
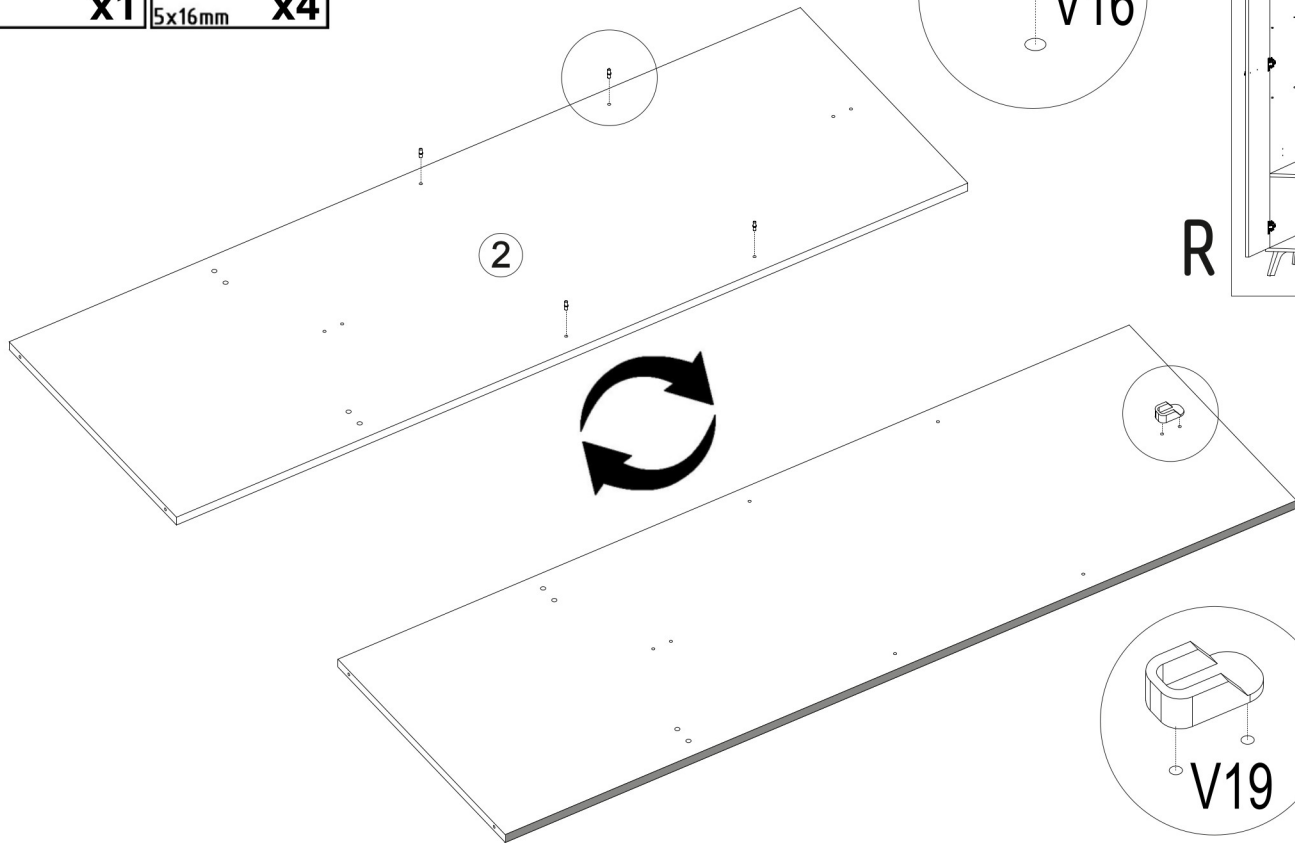

V19  x1	V16  5x16mm x4
---	---

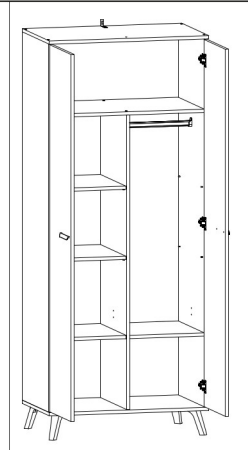
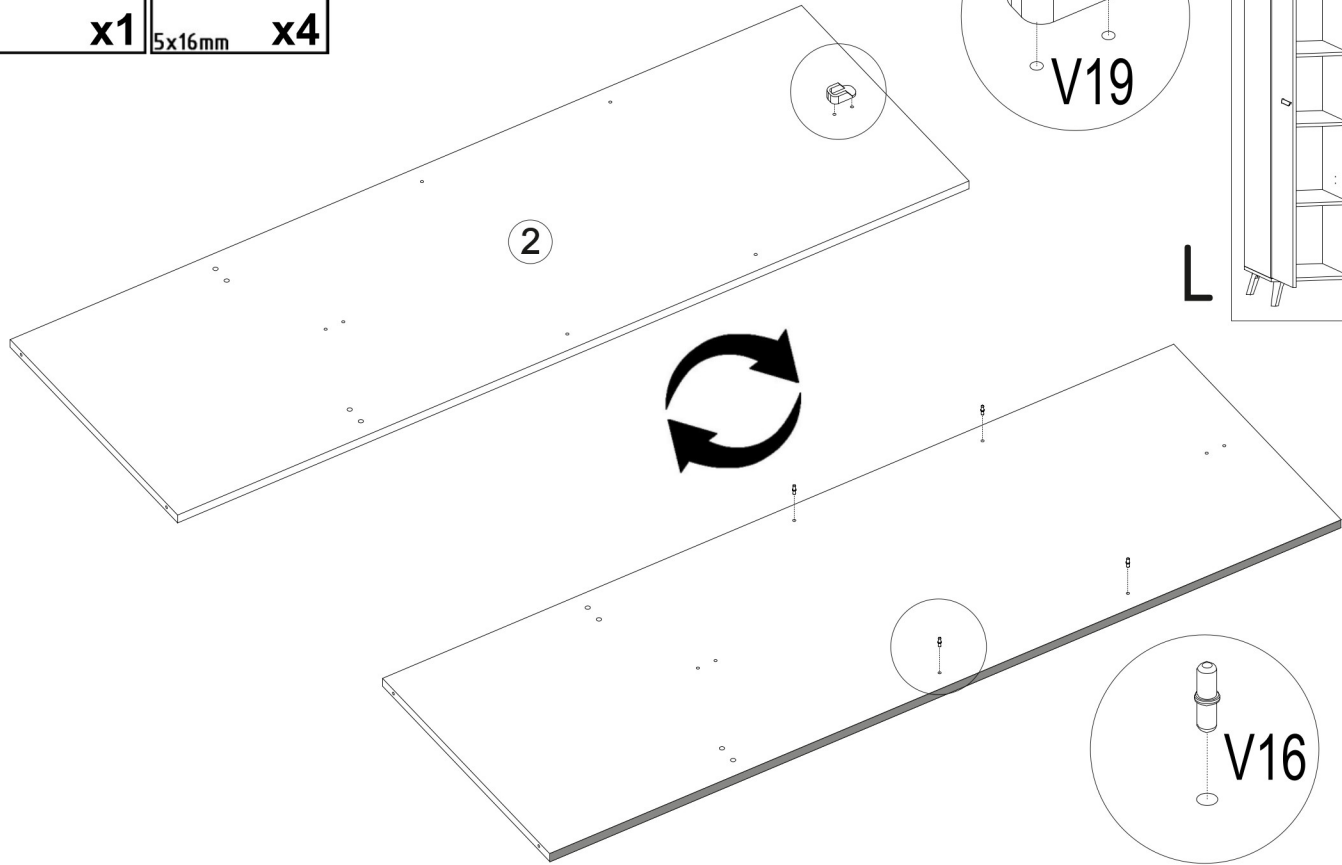

V19  x1	V16  5x16mm x4
---	---



M1

12x15mm **x12**

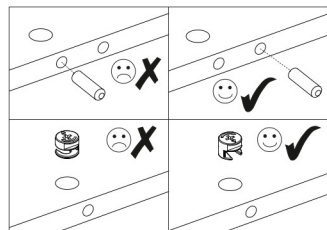
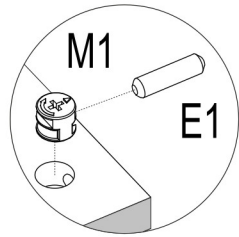
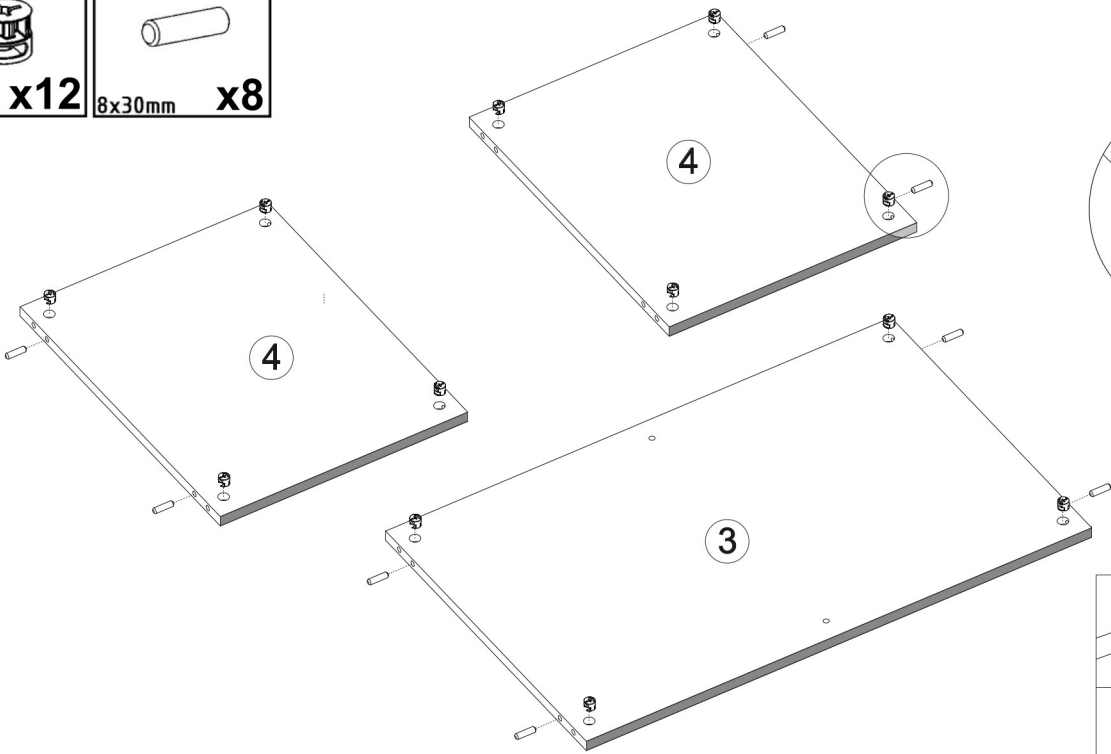
E1

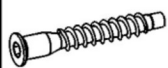
8x30mm **x8**

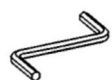

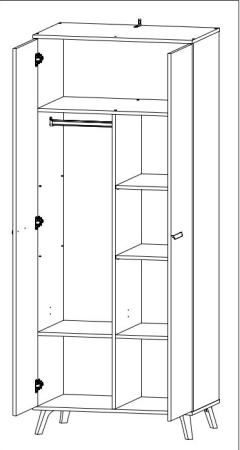
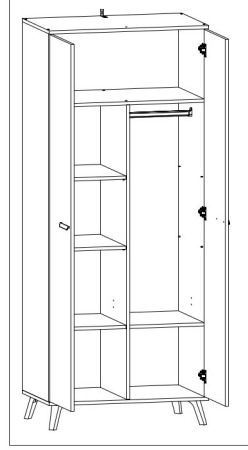
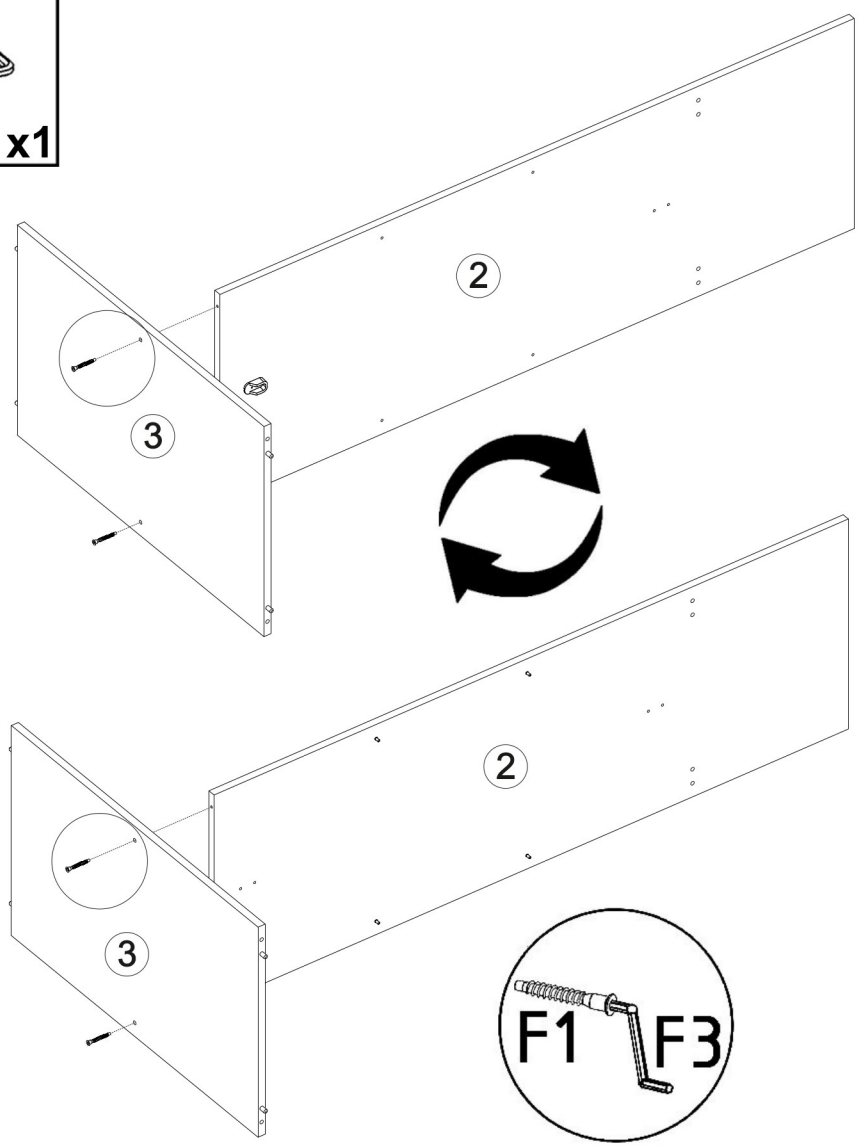
F1

7x50mm **x2**

F3

Hex 4mm **x1**

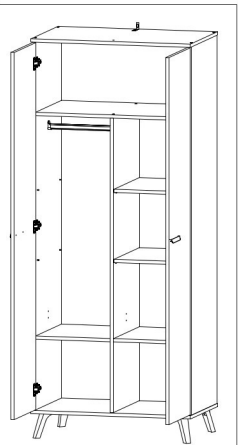
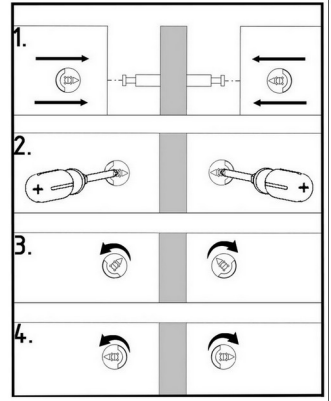
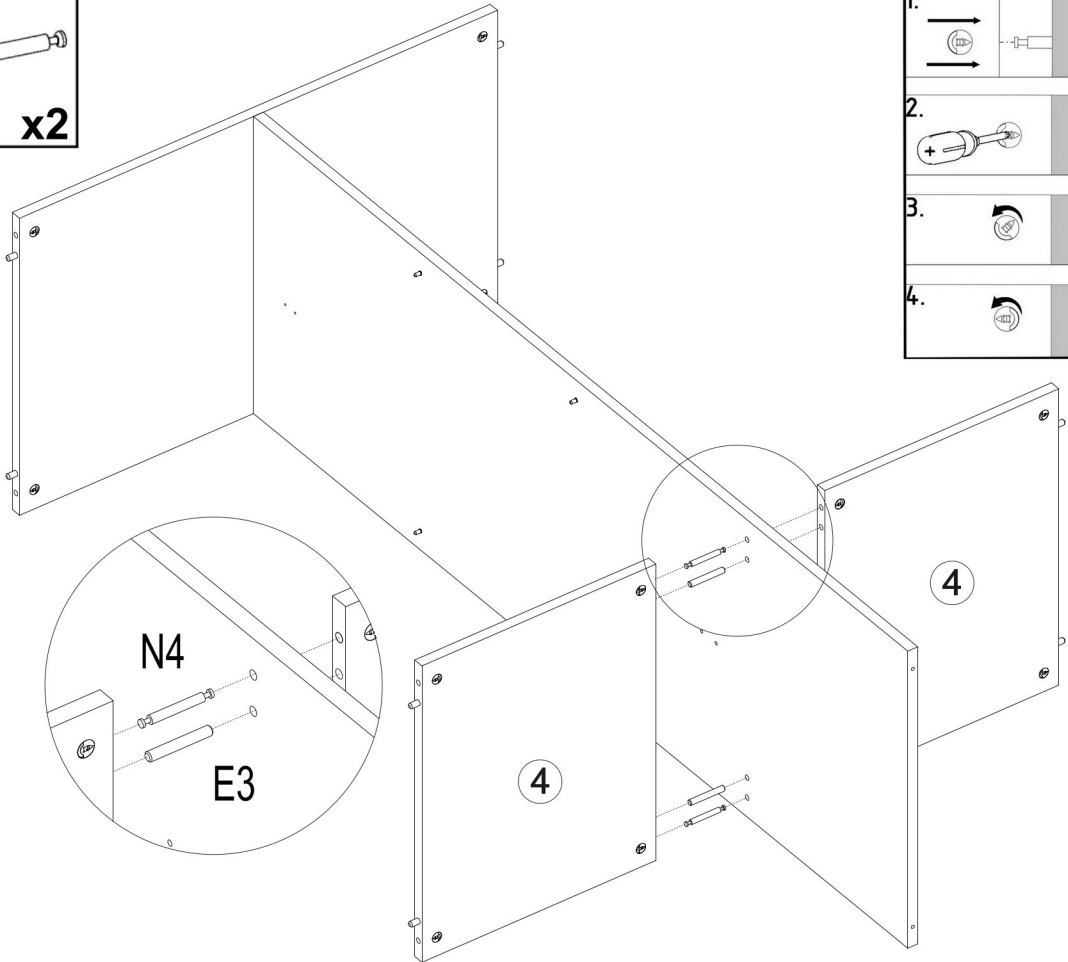
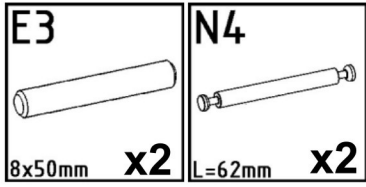

R





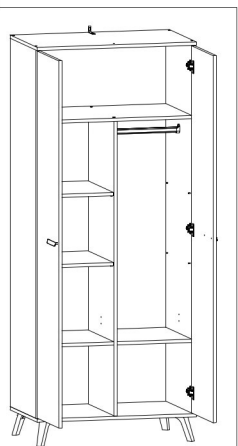
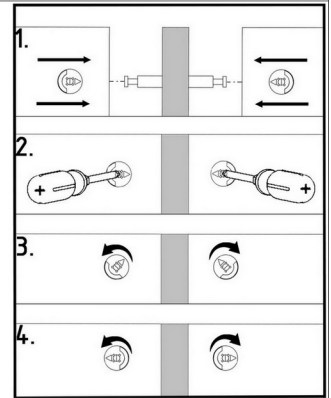
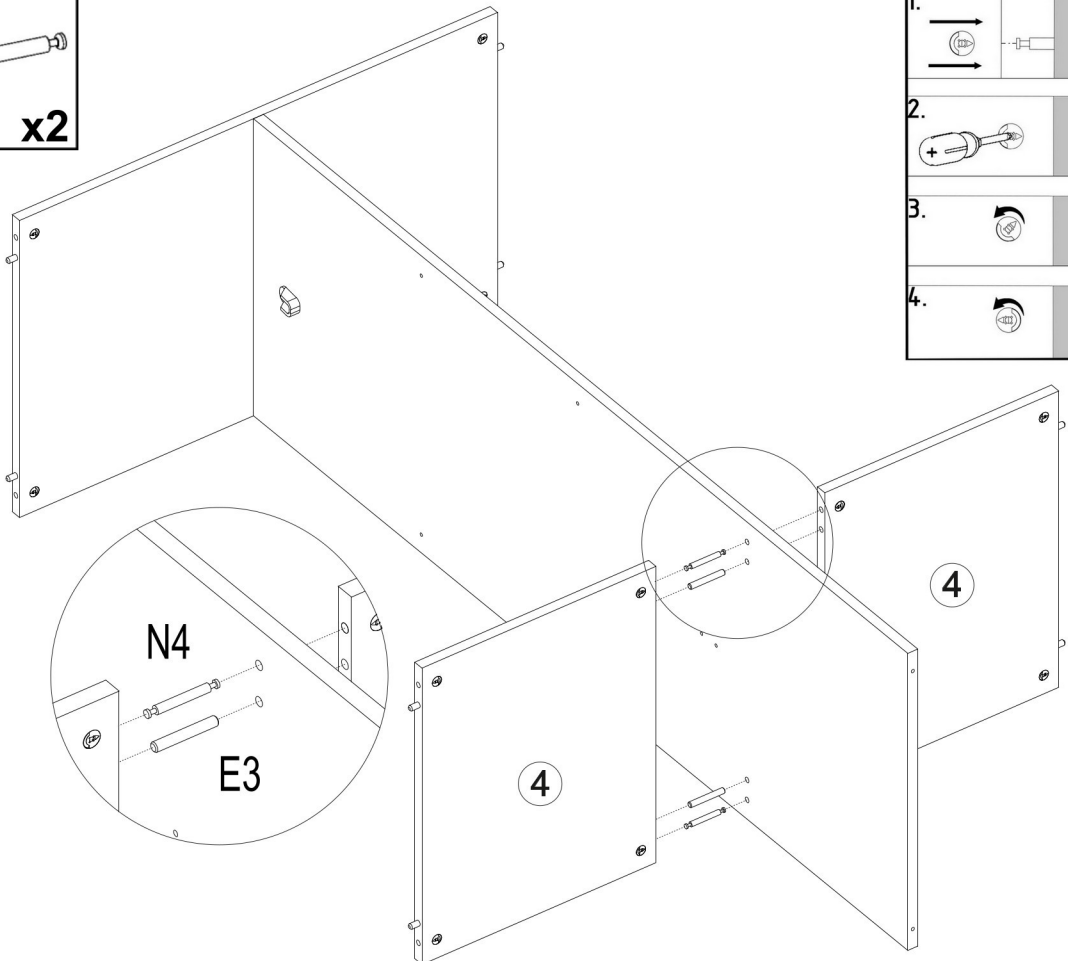
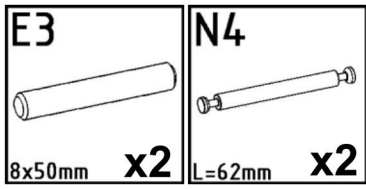

R



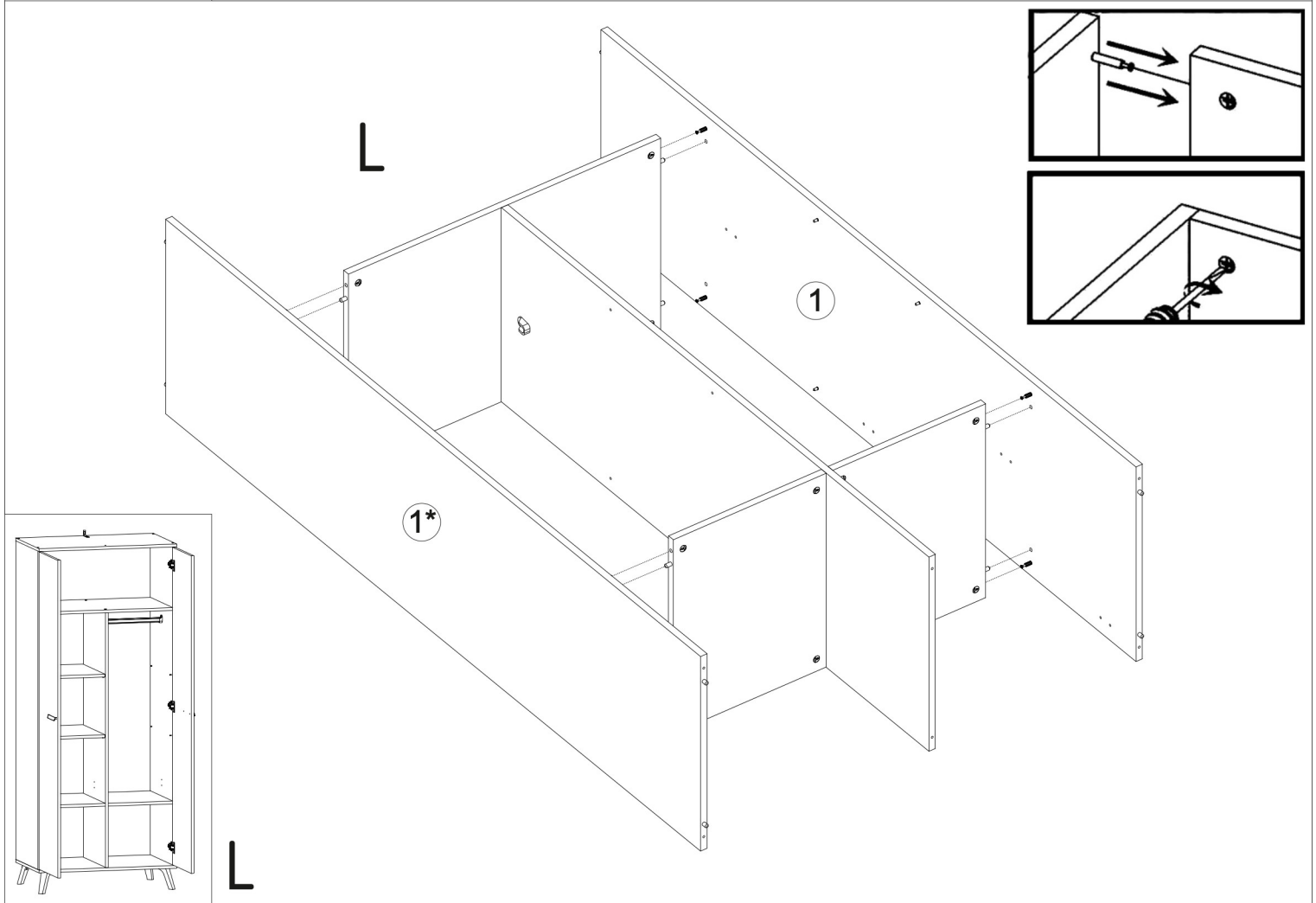
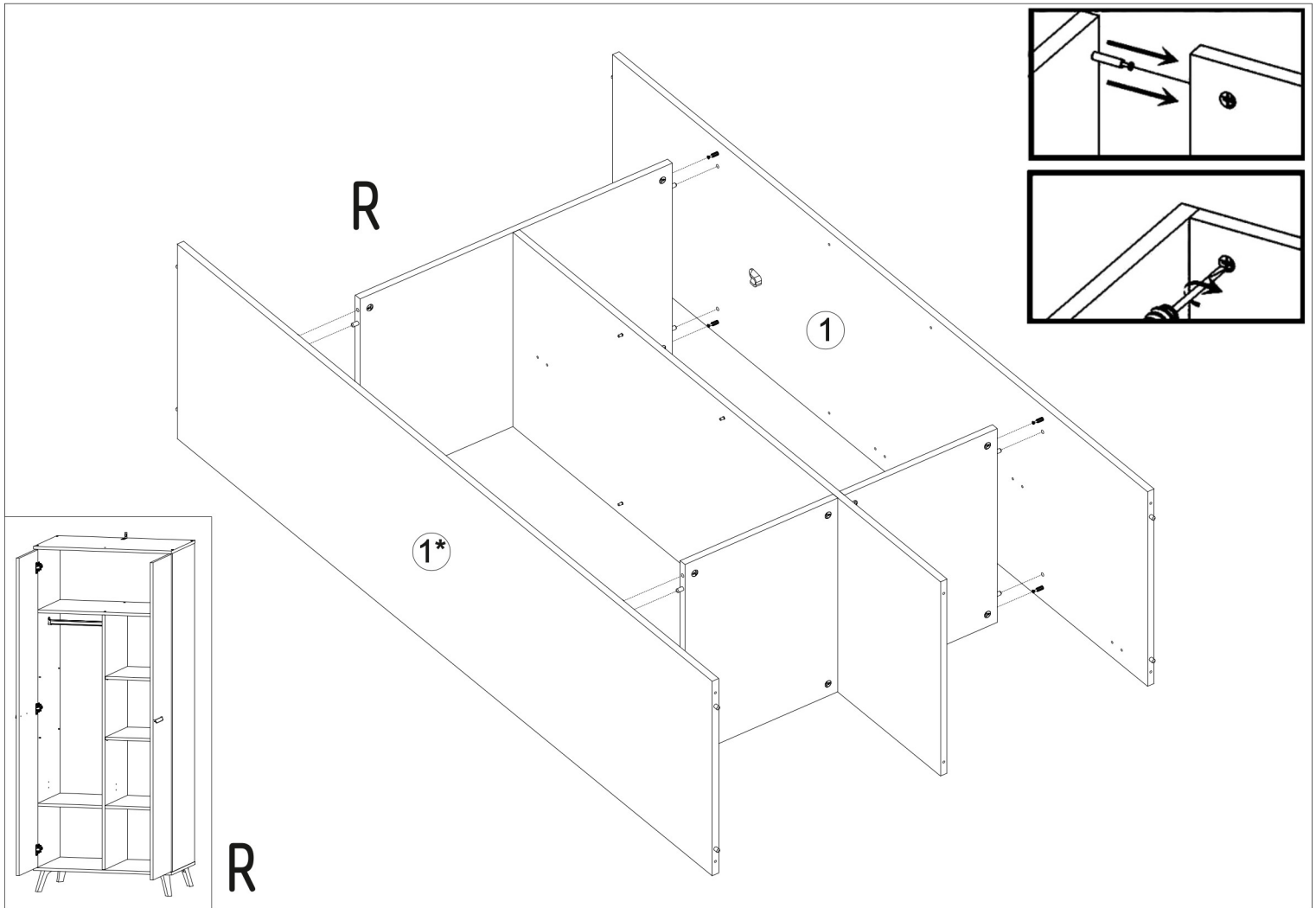

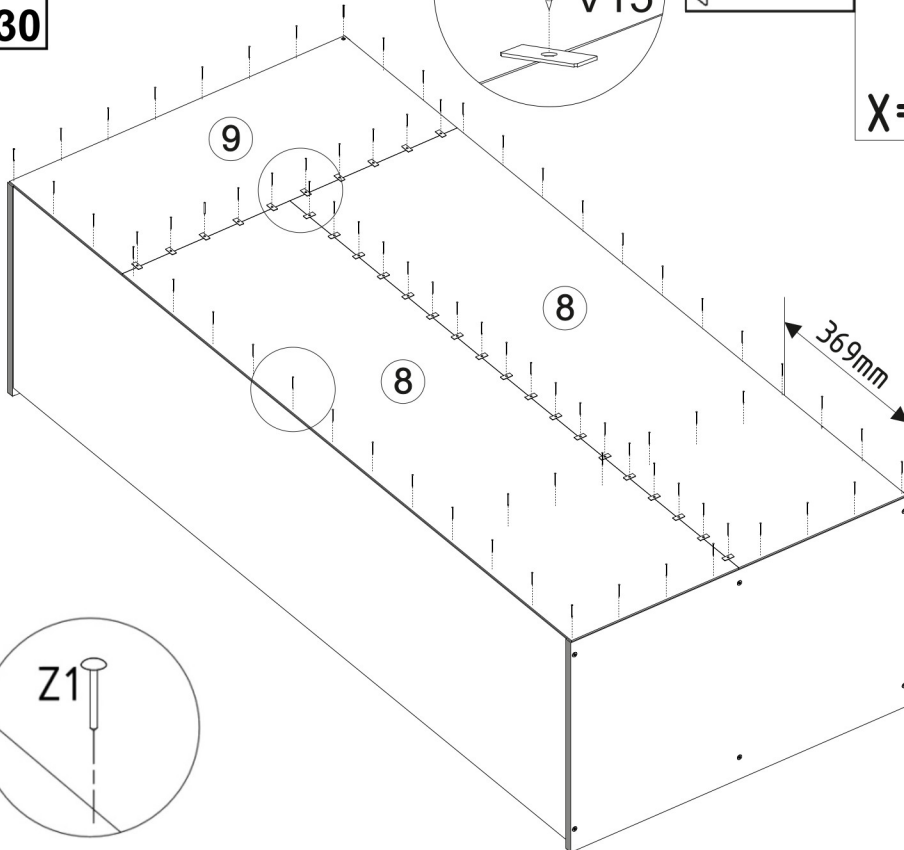
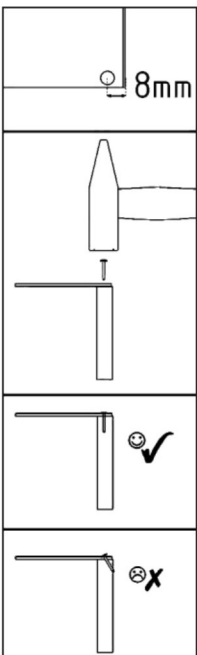
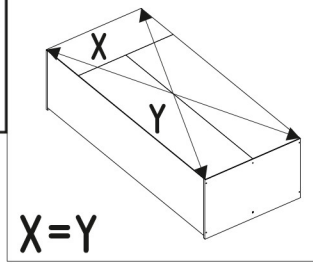
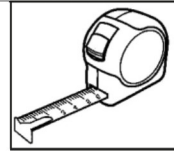
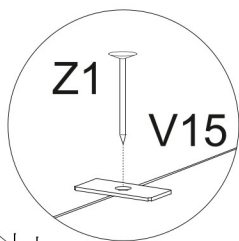
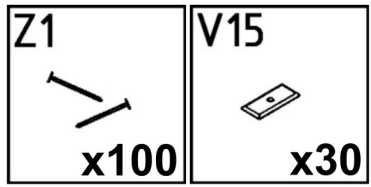
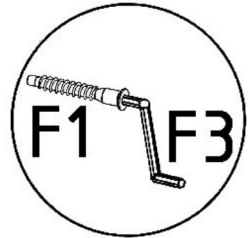
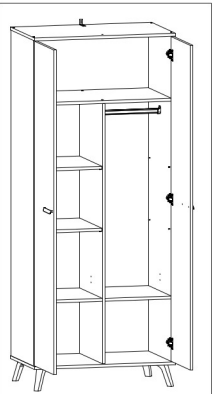
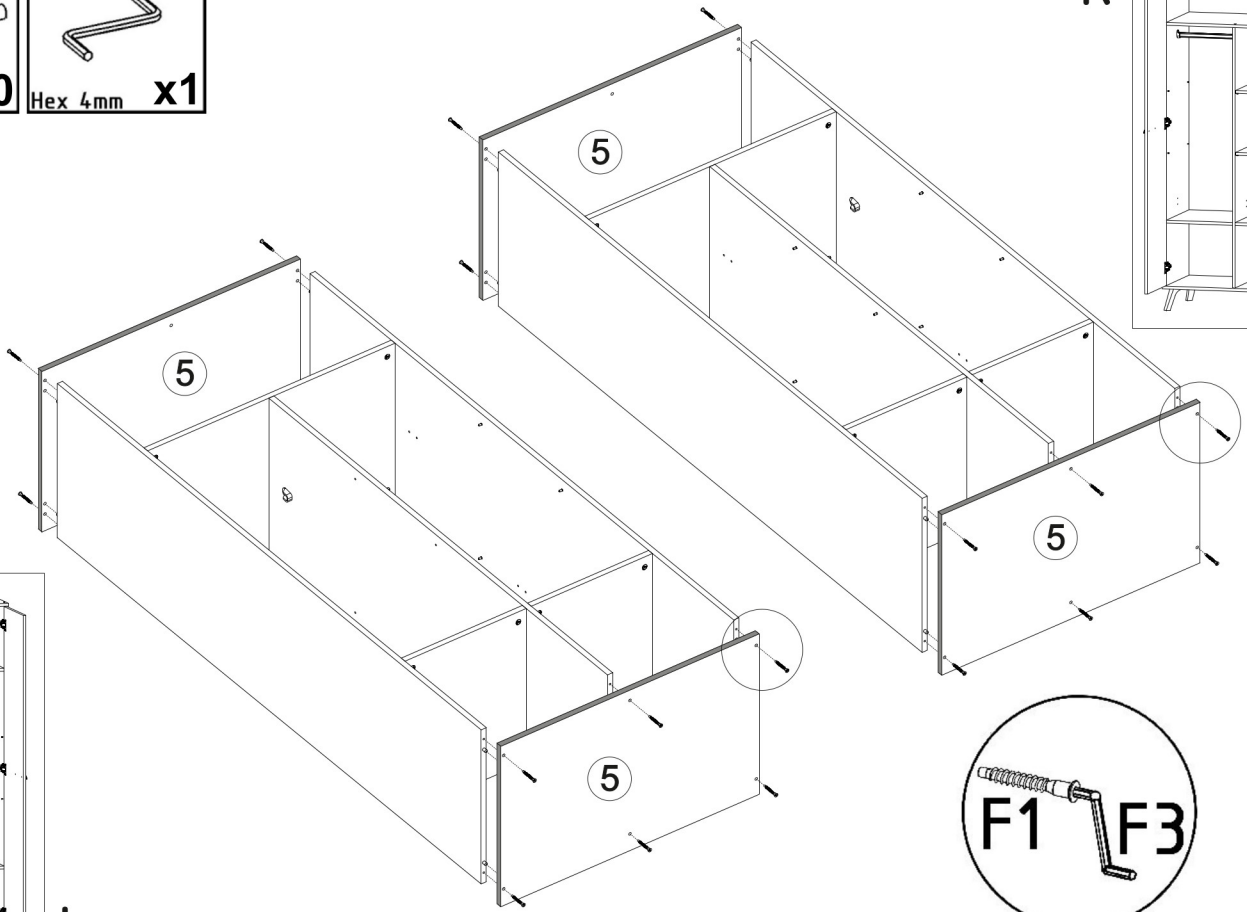
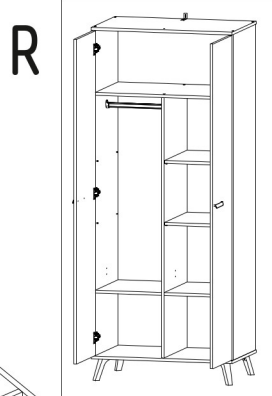
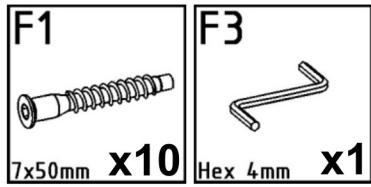
L



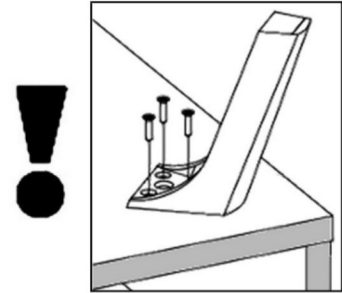
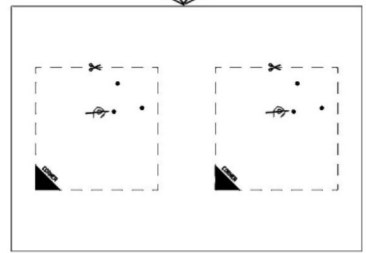
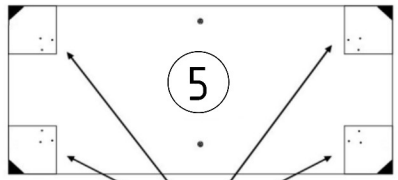
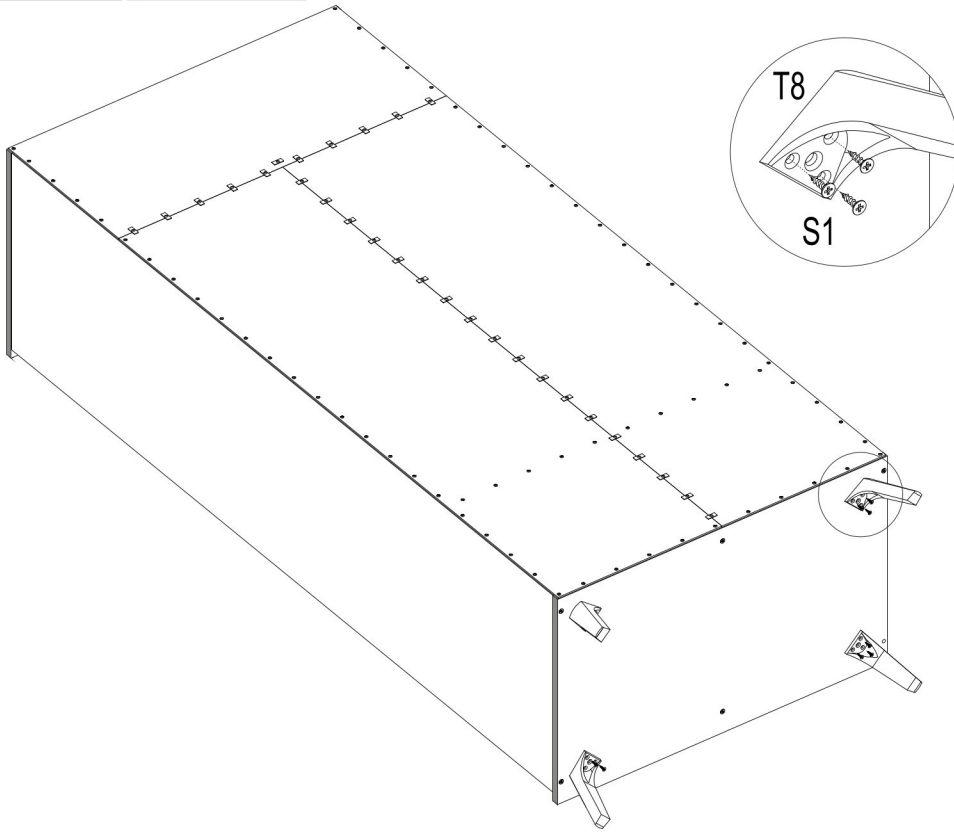

S1  3,5x16mm x12	T8  H=120mm x4
--	---



A1  ZP x6	S1  3,5x16mm x12
---	---

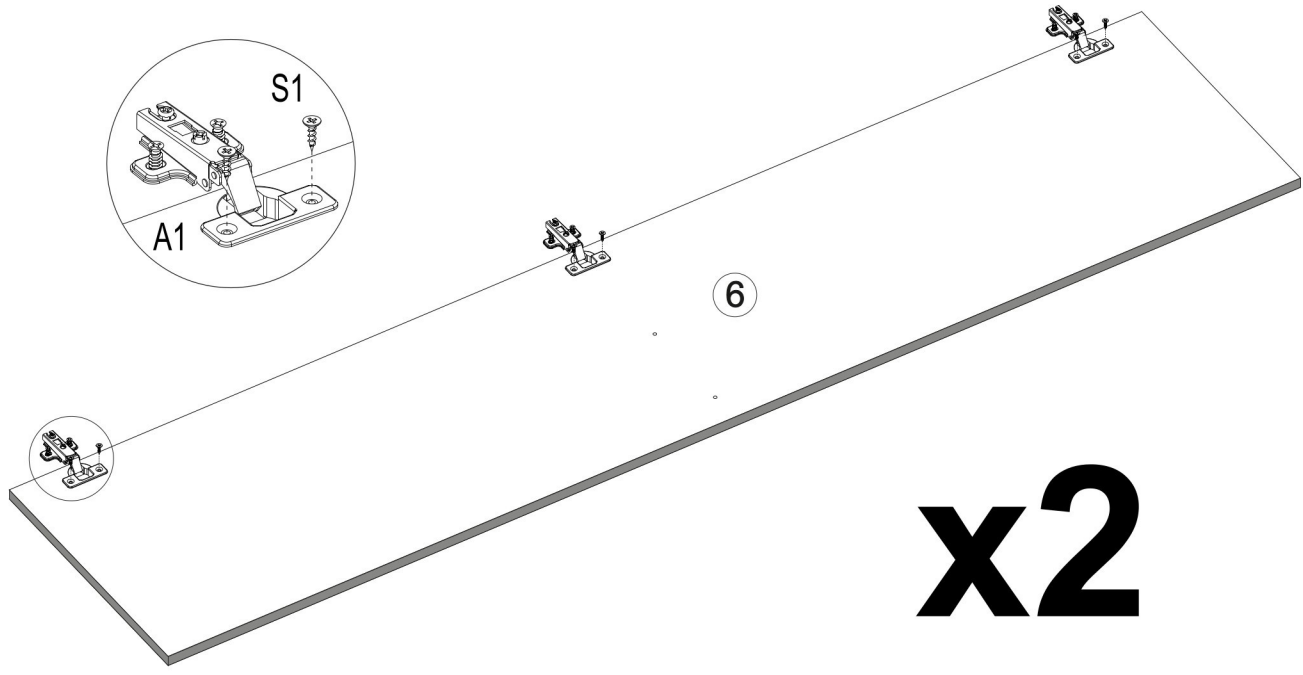

x2

